

PENTAX

SLR Digital Camera

K-3 III

Monochrome
Operating Manual

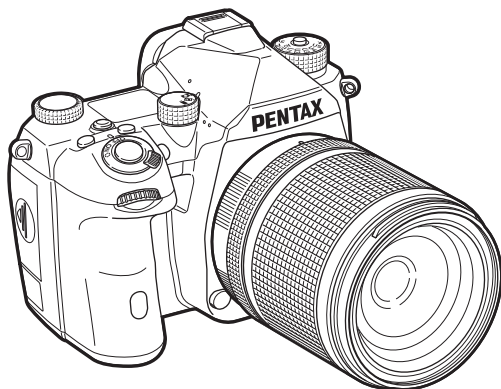

Model No. R03010

Introduction **1**

Getting Started **2**

Shooting **3**

Playback **4**

Sharing **5**

Settings **6**

Appendix **7**

This Operating Manual provides information on how to use the shooting and playback functions of this camera and related precautions.

Thoroughly read this Operating Manual to make the best use of the functions available with this camera. Be sure to keep this Operating Manual for future reference.

It is recommended to update the camera firmware to the latest version before using the camera.

For details on the latest firmware version, refer to the firmware download site.

<https://www.ricoh-imaging.com/>

RICOH IMAGING COMPANY, LTD.

For Using Your Camera Safely

We have paid close attention to the safety of this camera. When using this camera, we request your special attention regarding items marked with the following symbols.



Warning

This symbol indicates that ignoring this item could cause serious personal injuries.



Caution

This symbol indicates that ignoring this item could cause minor or medium personal injuries, or loss of property.

About the Camera



Warning

- Do not disassemble or modify the camera. High voltage areas are present inside the camera, with the risk of electric shock.
- If the camera interior is exposed due to dropping or otherwise damaging the camera, never touch the exposed portion. There is a risk of electric shock.
- Do not aim the camera at the sun or other strong light sources when taking images or leave the camera sitting in direct sunlight with a lens cap off. Doing so may cause the camera to malfunction or cause a fire.
- Do not look at the sun or other strong light sources through a lens. Doing so may lead to a loss of eyesight or cause vision to be impaired.
- If any irregularities occur during use, such as smoke or a strange odor, stop use immediately, remove the battery or the AC adapter, and contact your nearest service center. Continued use can cause a fire or electric shock.



Caution

- Some portions of the camera heat up during use. There is a risk of low temperature burns when holding such portions for long periods.
- Should the monitor be damaged, be careful of glass fragments. Also, be careful not to allow the liquid crystal to get on your skin or in your eyes or mouth.
- Depending on your individual factors or physical condition, the use of the camera may cause itching, rashes or blisters. In case of any abnormality, stop using the camera and get medical attention immediately.

About the USB Power Adapter



Warning

- Wipe off the power plug if it should become covered with dust. Accumulated dust may cause a fire.
- Do not handle the power plug with wet hands. This can cause an electric shock.
- Always grip the plug section when disconnecting the power plug. Do not pull the power cord. This can damage the power cord and result in a fire or electric shock.
- If the generation of smoke or strange odor from the adapter or other abnormality occurs, immediately remove the power plug from the outlet and contact your nearest dealer or service center for repair. Do not use the adapter until it is repaired.
- If you see a lightning flash or hear thunder during use of the adapter, do not touch the power plug. This can cause an electric shock.



Caution

- Securely insert the power plug into the outlet. Failure to observe this precaution may cause a fire.

About the Optional Battery Charger and AC Adapter

Warning

- Always use the optional battery charger and AC adapter exclusively developed for this camera, with the specified power and voltage. Using a battery charger or AC adapter not exclusive to this camera, or using the exclusive battery charger or AC adapter with an unspecified power or voltage can cause a fire, electric shock, or camera breakdown. The specified voltage is 100 to 240 VAC.
- Do not disassemble or modify the product. This can cause a fire or electric shock.
- If the generation of smoke or strange odor from the product or other abnormality occurs, immediately discontinue using and consult your nearest service center. Continued use can cause a fire or electric shock.
- If water should happen to get inside the product, consult your nearest service center. Continued use can cause a fire or electric shock.
- If you see a lightning flash or hear thunder during use of the battery charger or AC adapter, unplug the power plug and discontinue using. Continued use can cause damage to the product, fire, or electric shock.
- Wipe off the power plug if it should become covered with dust. Accumulated dust may cause a fire.

Caution

- Do not place or drop heavy objects on or forcefully bend the AC plug cord. Doing so may damage the cord. Should the AC plug cord be damaged, consult your nearest service center.
- Do not touch or short-circuit the terminal area of the AC plug cord while the cord is plugged in.
- Do not handle the power plug with wet hands. This can cause an electric shock.
- Do not drop the product, or subject it to violent impact. This can cause the product to breakdown.

About the Rechargeable Lithium-ion Battery

Warning

- If any leakage from the battery should come in contact with your eyes, do not rub them. Flush your eyes with clean water and get medical attention immediately.

Caution

- Only use the specified battery with this camera. Use of other batteries may cause an explosion or fire.
- Do not disassemble the battery. Disassembling the battery may cause an explosion or leakage.
- Remove the battery from the camera immediately if it becomes hot or begins to smoke. Be careful not to burn yourself during removal.
- Keep wires, hairpins, and other metal objects away from the + and - contacts of the battery.
- Do not short the battery or dispose of the battery in fire. This can cause an explosion or fire.
- If any leakage from the battery should come in contact with skin or clothing, it may cause irritation to the skin. Wash the affected areas thoroughly with water.
- Avoid the following actions regarding the battery:
 - Replacement of the battery with an incorrect type that can defeat a safeguard (for example, in the case of some lithium battery type)
 - Disposal of the battery into fire or a hot oven, or mechanically crushing or cutting of the battery, that can result in an explosion
 - Leaving the battery in an extremely high temperature surrounding environment that can result in an explosion or leakage of flammable liquid or gas
 - Subjecting the battery to extremely low air pressure that may result in an explosion or leakage of flammable liquid or gas
- Precautions for D-LI90 Battery Usage:
 - USE ONLY THE CAMERA OR SPECIFIED CHARGER TO CHARGE THE BATTERY. RISK OF FIRE AND BURNS.
 - DO NOT INCINERATE.
 - DO NOT DISASSEMBLE.
 - DO NOT SHORT CIRCUIT.
 - DO NOT EXPOSE TO HIGH TEMP. (140°F / 60°C)
 - SEE MANUAL.

Keep the Camera and its Accessories out of the Reach of Small Children

Warning

- Do not place the camera and its accessories within the reach of small children.
 1. If the product falls or is operated accidentally, it may cause serious personal injuries.
 2. Wrapping the strap around a neck may cause suffocation.
 3. To avoid the risk of a small accessory such as the battery or memory cards from being swallowed by mistake, keep them out of the reach of small children. Seek medical attention immediately if an accessory is accidentally swallowed.

How to Use This Manual

1

Introducing the K-3 Mark III Monochromep.8

Gives you an overview of the K-3 Mark III Monochrome.
Read this and get to know your K-3 Mark III Monochrome!

- Checking the Contents of the Package**p.8
- Names and Functions of the Working Parts**p.9
- Display Indicators**p.12
- How to Change Function Settings**p.18
- Menu List**p.22

2

Getting Started.....p.36

Explains how to get your K-3 Mark III Monochrome ready for shooting as well as basic operations.

- Attaching the Strap**p.36
- Attaching a Lens**p.36
- Using the Battery and Charger**p.37
- Inserting a Memory Card**p.40
- Initial Settings**p.41
- Basic Shooting Operation**p.43
- Reviewing Images**p.46

3

Taking Images.....p.47

Once you've confirmed that the camera works properly, try out the camera and take lots of images!

- Configuring the Capture Settings**p.47
- Taking Still Images**p.48
- Recording Movies**p.54
- Setting the Exposure**p.57
- Setting the Focus Method**p.59
- Selecting the Drive Mode**p.67
- Using a Flash**p.75
- Controlling the Image Finishing Tone**p.76
- Correcting Images**p.78

4**Playback Functions.....p.82**

Explains various operations for playing back and editing images.

- Using the Playback Functionsp.82**
- Changing the Playback Methodp.82**
- Organizing Filesp.85**
- Editing and Processing Imagesp.88**

5**Sharing Images.....p.93**

Explains how to connect your K-3 Mark III Monochrome to a computer or communication device to operate the camera and use images in the camera.

- Using the Camera with a Computerp.93**
- Using the Camera with a Communication Devicep.95**

6**Changing the Settingsp.96**

Explains how to change other settings.

- Camera Settingsp.96**
- File Management Settingsp.107**

7**Appendix.....p.111**

Provides other resources to get the most from your K-3 Mark III Monochrome.

- Restrictions on the Combinations of Special Functionsp.111**
- Functions Available with Various Lensesp.112**
- Functions when Using an External Flashp.115**
- Using the GPS Unitp.117**
- Troubleshootingp.120**
- Main Specificationsp.123**
- Indexp.128**
- Care to be Taken During Handlingp.132**
- WARRANTY POLICYp.135**

There is a possibility that the illustrations and the display screen of the monitor in this manual are different from the actual ones.

Contents

| | |
|-------------------------------------|----------|
| How to Use This Manual | 2 |
|-------------------------------------|----------|

| | |
|---|----------|
| Introducing the K-3 Mark III Monochrome..... | 8 |
|---|----------|

| | |
|---|----------|
| Checking the Contents of the Package | 8 |
|---|----------|

| | |
|---|----------|
| Names and Functions of the Working Parts | 9 |
|---|----------|

| | |
|--------------------------|----|
| Operating Controls | 10 |
|--------------------------|----|

| | |
|---------------------------------|-----------|
| Display Indicators | 12 |
|---------------------------------|-----------|

| | |
|---------------|----|
| Monitor | 12 |
|---------------|----|

| | |
|--------------------------------|----|
| LCD Panel and Viewfinder | 16 |
|--------------------------------|----|

| | |
|------------------------|----|
| Electronic Level | 18 |
|------------------------|----|

| | |
|--|-----------|
| How to Change Function Settings | 18 |
|--|-----------|

| | |
|-----------------------------|----|
| Using the Direct Keys | 18 |
|-----------------------------|----|

| | |
|--------------------------------|----|
| Using the Smart Function | 19 |
|--------------------------------|----|

| | |
|-------------------------------|----|
| Using the Control Panel | 20 |
|-------------------------------|----|

| | |
|-----------------------|----|
| Using the Menus | 20 |
|-----------------------|----|

| | |
|------------------------|-----------|
| Menu List | 22 |
|------------------------|-----------|

| | |
|-----------------------------------|----|
| 📷 Still Image Setting Menus | 22 |
|-----------------------------------|----|

| | |
|-----------------------------|----|
| 🎬 Movie Setting Menus | 25 |
|-----------------------------|----|

| | |
|--------------------------------|----|
| ▶ Playback Setting Menus | 26 |
|--------------------------------|----|

| | |
|-----------------------------|----|
| Ⓒ Customization Menus | 27 |
|-----------------------------|----|

| | |
|---------------------|----|
| 🔧 Setup Menus | 33 |
|---------------------|----|

| | |
|------------------------------|-----------|
| Getting Started | 36 |
|------------------------------|-----------|

| | |
|----------------------------------|-----------|
| Attaching the Strap | 36 |
|----------------------------------|-----------|

| | |
|-------------------------------|-----------|
| Attaching a Lens | 36 |
|-------------------------------|-----------|

| | |
|--|-----------|
| Using the Battery and Charger | 37 |
|--|-----------|

| | |
|--------------------------------------|----|
| Inserting/Removing the Battery | 37 |
|--------------------------------------|----|

| | |
|----------------------------|----|
| Charging the Battery | 38 |
|----------------------------|----|

| | |
|----------------------------|----|
| Using the AC Adapter | 40 |
|----------------------------|----|

| | |
|--------------------------------------|-----------|
| Inserting a Memory Card | 40 |
|--------------------------------------|-----------|

| | |
|-------------------------------|-----------|
| Initial Settings | 41 |
|-------------------------------|-----------|

| | |
|-----------------------------|----|
| Turning the Camera On | 41 |
|-----------------------------|----|

| | |
|--|----|
| Setting the Display Language, Date and Time, and Color | 42 |
|--|----|

| | |
|--------------------------------|----|
| Formatting a Memory Card | 42 |
|--------------------------------|----|

| | |
|---------------------------------------|-----------|
| Basic Shooting Operation | 43 |
|---------------------------------------|-----------|

| | |
|------------------------------------|----|
| Shooting with the Viewfinder | 43 |
|------------------------------------|----|

| | |
|--|----|
| Shooting while Viewing the Live View Image | 45 |
|--|----|

| | |
|-------------------------------|-----------|
| Reviewing Images | 46 |
|-------------------------------|-----------|

| | |
|----------------------------|-----------|
| Taking Images | 47 |
|----------------------------|-----------|

| | |
|---|-----------|
| Configuring the Capture Settings | 47 |
|---|-----------|

| | |
|--------------------------------------|----|
| Memory Card Recording Settings | 47 |
|--------------------------------------|----|

| | |
|------------------------------------|----|
| Still Image Capture Settings | 47 |
|------------------------------------|----|

| | |
|------------------------------|----|
| Movie Capture Settings | 48 |
|------------------------------|----|

| | |
|----------------------------------|-----------|
| Taking Still Images | 48 |
|----------------------------------|-----------|

| | |
|----------------------|----|
| Exposure Modes | 49 |
|----------------------|----|

| | |
|-----------------------|----|
| EV Compensation | 53 |
|-----------------------|----|

| | |
|------------------------------------|----|
| Using the Electronic Shutter | 54 |
|------------------------------------|----|

| | |
|-------------------------------|-----------|
| Recording Movies | 54 |
|-------------------------------|-----------|

| | |
|---------------------------|----|
| Playing Back Movies | 56 |
|---------------------------|----|

| | |
|-----------------------------------|-----------|
| Setting the Exposure | 57 |
|-----------------------------------|-----------|

| | |
|-----------------------|----|
| ISO Sensitivity | 57 |
|-----------------------|----|

| | |
|-------------------|----|
| AE Metering | 59 |
|-------------------|----|

| | |
|---------------------------------------|-----------|
| Setting the Focus Method | 59 |
|---------------------------------------|-----------|

| | |
|---|----|
| Setting the Autofocus when Shooting with the Viewfinder | 60 |
|---|----|

| | |
|--|----|
| Setting the Autofocus when Shooting with Live View | 63 |
|--|----|

| | |
|---------------------------------|----|
| Fine-tuning the Autofocus | 65 |
|---------------------------------|----|

| | |
|---|----|
| Checking the Depth of Field (Preview) | 66 |
|---|----|

| | |
|---------------------------------------|-----------|
| Selecting the Drive Mode | 67 |
|---------------------------------------|-----------|

| | |
|---------------------------|----|
| Continuous Shooting | 68 |
|---------------------------|----|

| | |
|------------------|----|
| Bracketing | 68 |
|------------------|----|

| | |
|---------------------------------|----|
| Depth of Field Bracketing | 69 |
|---------------------------------|----|

| | |
|-------------------------|----|
| Motion Bracketing | 70 |
|-------------------------|----|

| | |
|-------------------------------|----|
| Mirror Lock-up Shooting | 70 |
|-------------------------------|----|

| | | | |
|---|-----------|--|------------|
| Multi-exposure | 71 | Sharing Images | 93 |
| Interval Shooting | 72 | Using the Camera with a Computer | 93 |
| Interval Composite | 73 | Setting the Connection Mode | 93 |
| Self-timer | 74 | Copying an Image on the Memory Card | 93 |
| Remote Control | 74 | Installing the Provided Software | 94 |
| Using a Flash | 75 | Operating the Camera with a Computer | 94 |
| Connecting a Flash | 75 | Using the Camera with a Communication | |
| Setting the Flash Mode | 75 | Device | 95 |
| Controlling the Image Finishing Tone | 76 | Changing the Settings | 96 |
| Custom Image | 76 | Camera Settings | 96 |
| Digital Filter | 77 | Saving Frequently Used Settings | 96 |
| Correcting Images | 78 | Customizing the Operating Controls | 98 |
| Adjusting the Brightness | 78 | Setting the Monitor Display, Indicator Lamp | |
| Adjusting the Lens Properties | 79 | Illumination, and Sound Effects | 103 |
| Adjusting the Image Quality Level and Texture | 80 | Selecting Settings to Save in the Camera | 107 |
| Reducing Blurring of Images | 80 | File Management Settings | 107 |
| Correcting the Skew of Images | 81 | Specifying the Folder/File Settings | 107 |
| Fine-tuning the Composition | 81 | Setting the Copyright Information | 110 |
| Playback Functions | 82 | Appendix | 111 |
| Using the Playback Functions | 82 | Restrictions on the Combinations of Special | |
| Setting the Operation in the Playback Mode | 82 | Functions | 111 |
| Changing the Playback Method | 82 | Functions Available with Various Lenses | 112 |
| Displaying Multiple Images | 82 | Using the Aperture Ring | 114 |
| Displaying Images by Folder or Shooting Date | 84 | Setting the Focal Length | 115 |
| Connecting the Camera to an AV Device | 84 | Functions when Using an External Flash | 115 |
| Organizing Files | 85 | Using the GPS Unit | 117 |
| Deleting Images | 85 | Shooting Celestial Bodies (ASTROTRACER) | 117 |
| Protecting Images | 86 | Troubleshooting | 120 |
| Rotating Images | 86 | Sensor Cleaning | 121 |
| Copying Images | 87 | Error Messages | 122 |
| Transferring Images | 87 | Main Specifications | 123 |
| Saving the RAW Data | 88 | Camera | 123 |
| Editing and Processing Images | 88 | Operating Environment for USB Connection and | |
| Processing Images with Digital Filters | 88 | Provided Software | 127 |
| Developing RAW Images | 89 | Index | 128 |
| Changing the Image Size | 90 | | |
| Correcting JPEG Images | 91 | | |
| Editing Movies | 92 | | |

| | |
|--|-----|
| Care to be Taken During Handling | 132 |
| WARRANTY POLICY | 135 |

Regarding copyrights

Images taken with this camera that are for anything other than personal enjoyment cannot be used without permission according to the rights as specified in the Copyright Act. Please take care, as there are cases where limitations are placed on taking images even for personal enjoyment during demonstrations, performances or of items on display. Images taken with the purpose of obtaining copyrights also cannot be used outside the scope of use of the copyright as laid out in the Copyright Act, and care should be taken here also.

To users of this camera

- Do not use or store this camera in the vicinity of equipment that generates strong electromagnetic radiation or magnetic fields. Strong static charges or the magnetic fields produced by equipment such as radio transmitters could interfere with the monitor, damage the stored data, or affect the camera's internal circuitry and cause camera misoperation.
- The liquid crystal panel used for the monitor is manufactured using extremely high precision technology. Although the level of functioning pixels is 99.99% or better, you should be aware that 0.01% or fewer of the pixels may not light up or may light up when they should not. However, this has no effect on the recorded image.
- The Shake Reduction (SR) mechanism of this camera uses the PENTAX original technology and moves the image sensor to an appropriate position at high speed with a magnetic force, which reduces image blurring caused by camera motion. A rattling sound is made when the camera is shaken, for example, by changing its orientation, but this is not a malfunction.
- In this manual, the generic term "computer(s)" refers to either a Windows® PC or a Mac.
- In this manual, the term "battery(ies)" refers to any type of batteries used for this camera and its accessories.

Regarding User Registration

In order to better serve you, we request that you complete the user registration which can be found on our website. Thank you for your cooperation.

<https://www.ricoh-imaging.com/registration/>

Introducing the K-3 Mark III Monochrome

1

Getting Started

2

Taking Images

3

Playback Functions

4

Sharing Images

5

Changing the Settings

6

Appendix

7

Checking the Contents of the Package

1

Introduction



Hot shoe cover Fk
(Installed on the camera)



Eyecup Fu
(Installed on the camera)



ME viewfinder cap



Sync socket 2P cap
(Installed on the camera)



Body mount cap K II
(Installed on the camera)



Triangular ring and protective cover
(Installed on the camera)



Battery grip terminal cover
(Installed on the camera)



Rechargeable lithium-ion
battery D-LI90

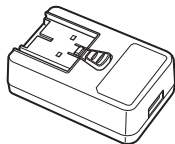

USB power adapter
AC-U1 or AC-U2*

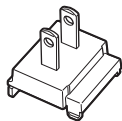

Power plug

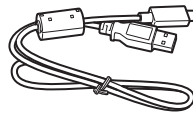

USB cable
I-USB166

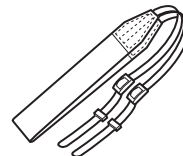

Strap
O-ST162

* Differs depending on the region.

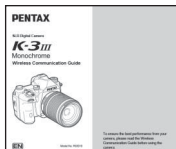
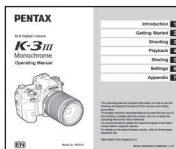

Operating Manual (this manual) Wireless Communication Guide

Lenses You Can Use

Lenses that can be used with this camera are D FA, DA, DA L, FA, and FA J lenses and lenses that have an **A** (Auto) position on the aperture ring. To use any other lens or accessory, see p.112.

Names and Functions of the Working Parts

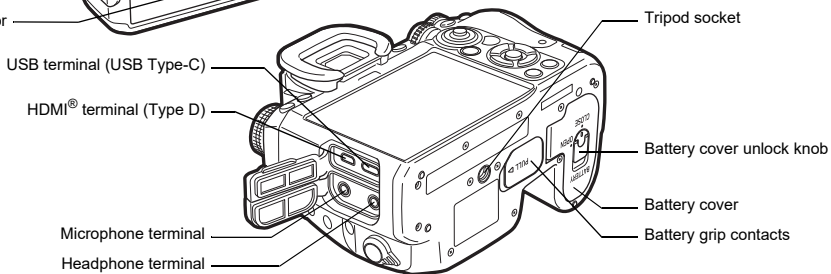
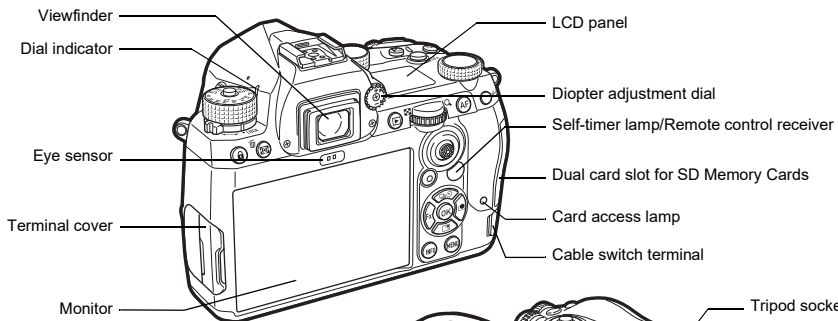
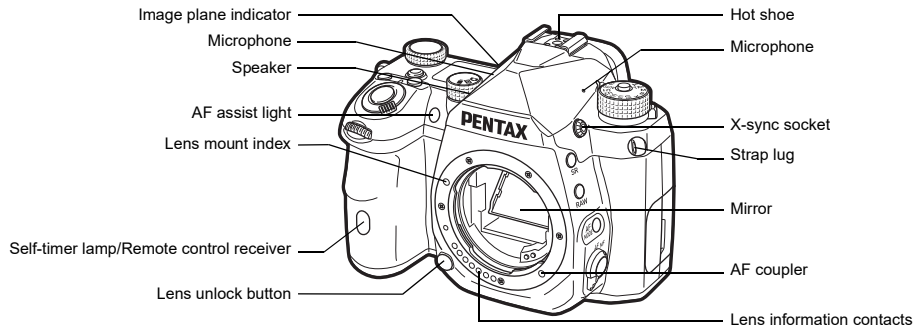

Operating Controls

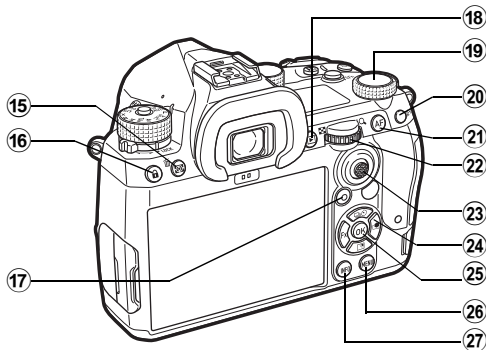
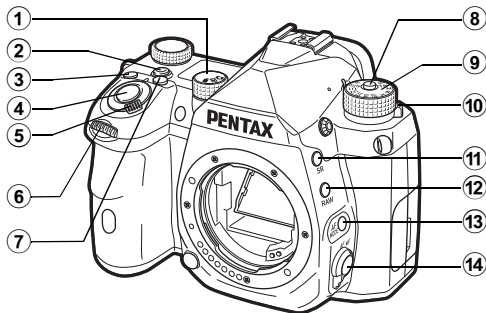

- ① **Still image/Live View/Movie selector dial** (📷/LV/🎬 dial)
Switches between shooting with the viewfinder in the 📷 (still image) mode, shooting with Live View in the 📷 mode, and shooting in the 🎬 (movie) mode. (p.43)
- ② **Smart Function button (S.Fn)**
Press to select the function set with the Smart Function and change settings for the selected function. (p.19)

- ③ **ISO button (ISO)**
Press to change the ISO sensitivity. (p.57)
- ④ **Shutter release button (SHUTTER)**
Press to capture images. (p.44)
In the playback mode, press halfway to switch to the capture mode.
- ⑤ **Main switch**
Turns the power on or off, or activates the preview function. (p.41, p.66)
- ⑥ **Front e-dial** (🔄)
Changes the values for camera settings such as exposure. (p.50)
You can change the menu type when a menu screen is displayed. (p.20)
In the playback mode, use this dial to select a different image.
- ⑦ **EV Compensation button (EV)**
Press to change the exposure compensation value. (p.53)
- ⑧ **Mode dial lock button**
Press to allow the mode dial to be turned. (p.43)
- ⑨ **Mode dial**
Changes the capture mode. (p.48)
- ⑩ **Mode dial lock release lever**
Use this lever to release the mode dial lock to operate the mode dial without pressing the mode dial lock button. (p.44)
- ⑪ **Shake Reduction button (SR)**
Changes the Shake Reduction function. (p.80)
- ⑫ **RAW button (RAW)**
Temporarily changes the file format. (p.99)
- ⑬ **AF Mode button (AF MODE)**
Press to change the AF mode or the AF active area. (p.60)
- ⑭ **Focus method switch**
Changes the focus method. (p.59)
- ⑮ **AE Metering/Delete button (AE/🗑️)**
Press to change the metering mode. (p.59)
In the playback mode, press to delete images. (p.46)

- 16 Operation lock button (L)**
Temporarily disables button operations to prevent misoperation. (p.45)
- 17 Green button (G)**
Resets the value being adjusted.
Switches to ISO Auto when adjusting the ISO sensitivity.
In the playback mode, press this button to switch between the memory cards inserted in the two slots, SD1 and SD2. (p.46)
- 18 Playback button (P)**
Switches to the playback mode. (p.46) Press the button again to switch to the capture mode.
- 19 Smart Function dial (S)**
Change settings for the function selected with the Smart Function. (p.19)
- 20 AE Lock button (AE-L)**
Locks the exposure value before shooting.
In the playback mode, press this button to display the playback function selection screen. (p.82)
- 21 AF button (AF)**
Available for adjusting focus, instead of pressing **SHUTTER** halfway. (p.59)
- 22 Rear e-dial (E)**
Changes the values for camera settings such as exposure. (p.50)
Changes the menu items when a menu screen is displayed. (p.20)
You can change camera settings when the control panel is displayed. (p.20)
In the playback mode, use this dial to magnify the image or display multiple images at the same time. (p.46, p.82)
- 23 AF point selector lever (AF-ON)**
Changes the AF point. (p.60) The AF point can be moved up, down, left, right, and diagonally.
When an image is magnified during shooting with Live View or in the playback mode, use this lever to move the display area. Push the lever in to return the display area to the center of the image. (p.45, p.46)
- 24 Four-way controller (▲▼◀▶)**
Displays the setting screen for [Drive Mode], [Outdoor View Setting], or [Custom Image]. (p.18)
When a menu or the control panel is displayed, use this controller to move the cursor or change the item to set.
- 25 OK button (OK)**
When a menu or the control panel is displayed, press this button to confirm the selected item.
- 26 MENU button (MENU)**
Displays a menu. Press this button while the menu is displayed to return to the previous screen. (p.20)
- 27 INFO button (INFO)**
Changes the style of the display on the monitor. (p.13, p.14)

About the Four-way Controller

In this manual, each button of the four-way controller is indicated as shown in the illustration on the right.

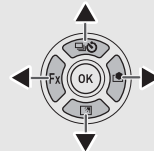

Customization of Operating Controls

For some buttons, you can change the button function to another one. (p.98)

This manual describes the camera operation based on the default function assignment.

Display Indicators

Monitor

Capture Mode

With this camera, you can take images while looking through the viewfinder or while viewing the image on the monitor.

When using the viewfinder, you can take images while checking the status screen displayed on the monitor and looking through the viewfinder. (p.43) When not using the viewfinder, you can take images while viewing the Live View image displayed on the monitor. (p.45)

The camera is in the “standby mode” when it is ready to shoot, such as when the status screen or Live View image is displayed.

Standby Mode

The settings for shooting are displayed.

Status Screen

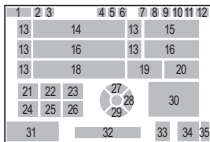

Live View

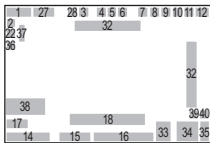



- 1 Capture mode (p.48)
- 2 AE Lock
- 3 Clarity (p.80)/Digital Filter (p.77)/HDR Capture (p.79)
- 4 GPS positioning status (p.117)
- 5 Bluetooth® communication
- 6 Wireless LAN communication
- 7 Flash Mode (p.75)
- 8 Shutter Mode Selection (p.54)
- 9 Anti-Aliasing Filter Simulator (p.80)
- 10 AE Metering (p.59)
- 11 Shake Reduction (p.80)/Auto Horizon Correction (p.81)
- 12 Battery level
- 13 E-dial guide
- 14 Shutter speed
- 15 Aperture value
- 16 ISO Sensitivity (p.57)
- 17 Operation guide for Smart Function (p.19)
- 18 EV bar scale
- 19 Focus method (p.59)
- 20 Hold AF Status (p.61)
- 21 Operation guide for **SR**
- 22 Operation guide for **A**
- 23 Operation guide for **IA**
- 24 Operation guide for **RAW**
- 25 Operation guide for **Key**
- 26 Operation guide for **AE-L**
- 27 Drive Mode (p.67)
- 28 Custom Image (p.76)
- 29 Outdoor View Setting
- 30 Focusing area (AF point) (p.60)
- 31 Date and time/Operation guide
- 32 Electronic level (p.18)
- 33 File Format (p.47)
- 34 Image storage capacity
- 35 Card slot number
- 36 Warning Display (p.106)
- 37 Temperature warning
- 38 Histogram
- 39 JPEG Recorded Pixels (p.47)
- 40 Crop (p.47)

Memo

- In [Monitor Display] of the **C4** menu, you can change the display settings of the status screen and Live View. (p.104)
- You can change the display color set in “Initial Settings” (p.41) in [Color Settings] of [Monitor Display] in the **C4** menu. (p.104)

Adjusting the Monitor Brightness

If the monitor display is difficult to see when you take images outdoors or in other situations, adjust the brightness of the monitor in [Outdoor View Setting] of the  2 menu. By default, [Outdoor View Setting] is assigned to . (p.98)

Also, when shooting in a dark place for a long period of time, you can prevent eyes dazzling in dark places by using [Night Vision Display] of the  2 menu.

In addition, you can set [Brightness], [Saturation], [Adjust: Blue-Amber], and [Adjust: Green-Magenta] in [Monitor Adjustment] of the  2 menu. [Brightness] can also be adjusted automatically. (By default, [Brightness] is adjusted automatically.) (p.105)

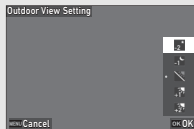

When the Camera is Held Vertically

When the camera is rotated to the vertical position, the status screen is displayed vertically.

To not display the status screen vertically, change the display rotation setting in [Status Screen] of [Monitor Display] in the  C4 menu. (p.104)



Control Panel

Press  in the standby mode to display the “control panel” and change settings.

The following functions are displayed with the default setting.

Mode

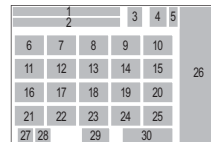

Mode

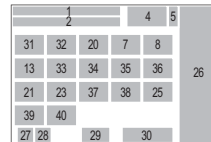
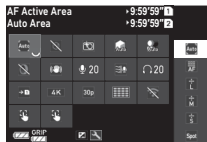

- 1 Function name
- 2 Setting
- 3 File Format (p.47)
- 4 Number of recordable still images/Movie recordable time
- 5 Card slot number
- 6 ISO Auto Upper Limit (p.57)
- 7 Highlight Correction (p.78)
- 8 Shadow Correction (p.78)
- 9 Slow Shutter Speed Noise Reduction (p.51)
- 10 High-ISO Noise Reduction (p.58)
- 11 Clarity (p.80)
- 12 Digital Filter (p.77)
- 13 HDR Capture (p.79)
- 14 Shutter Mode Selection (p.54)
- 15 Auto Horizon Correction (p.81)
- 16 Distortion Correction (p.79)
- 17 Peripheral Illumination Correction (p.79)
- 18 ASTROTRACER (p.117)
- 19 Anti-Aliasing Filter Simulator (p.80)
- 20 AF Assist Light (p.60)
- 21 Memory Card Options (p.47)
- 22 File Format (p.47)
- 23 JPEG Recorded Pixels (p.47)/Movie Recorded Pixels (p.48)
- 24 Program Line (p.51)
- 25 Wireless LAN Setting

- 26 List of setting options
- 27 Camera battery level
- 28 Battery grip battery level (when D-BG8 is attached)
- 29 Operation guide for the control panel customization (p.102)
- 30 Parameter
- 31 AF Active Area (p.63)
- 32 Focus Peaking (p.64)
- 33 Shake Reduction (p.80)
- 34 Recording Sound Level (p.48)
- 35 Wind Noise Reduction (p.48)
- 36 Headphone Volume (p.48)
- 37 Framerate (p.48)
- 38 Grid Style
- 39 Live View Shooting Touch AF (p.50)
- 40 Movie Recording Touch AF (p.55)

● Memo

- Refer to “Using the Control Panel” (p.20) for how to use the control panel.
- The functions displayed on the control panel can be changed in [Control Panel] of the **C5** menu. (p.102)

Changing the Shooting Information Display

The shooting information display changes each time **INFO** is pressed in the standby mode.

| | |
|--|---|
| When shooting with the viewfinder | Status Screen → Control Panel → Display Off → Status Screen |
| When shooting with Live View | Standard Information Display → Control Panel → Simplified Information Display → No Information Display → Standard Information Display |

● Memo

- The information displayed on Live View can be customized in [Live View] of [Monitor Display] in the **C4** menu. (p.104)

Playback Mode

The captured image and shooting information are displayed in the single image display of the playback mode.

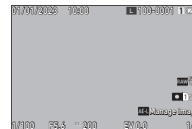

Press **INFO** to change the type of information displayed in the single image display.

| | |
|-------------------------------------|---|
| Standard Information Display | Captured image, file format, JPEG recorded pixels, exposure parameters, and operation guide indicators are displayed. |
| Detailed Information Display | Detailed information on how and when the image was taken is displayed. (p.15) |
| No Information Display | Only the captured image is displayed. |

● Memo

- The playback information display can be set in [Playback Info Display] of [Monitor Display] in the **C4** menu. (p.104)
- When the camera is turned off and on again and enters the playback mode, an image is displayed in the single image display with the information displayed last. If [Playback Info Display] is set to (Off) in [Memory] of the **C5** menu, the Standard Information Display always appears first when the camera is turned on. Also, if [Image for Playback] is set to (On) in [Memory], the last image played back is displayed first next time. (p.107)

Detailed Information Display

Still Images



Movies

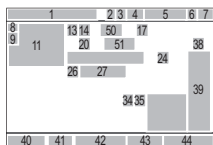

Page 2

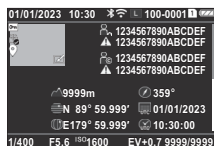

- 1 Shooting date and time
- 2 Bluetooth® communication
- 3 Wireless LAN communication
- 4 File Format, JPEG Recorded Pixels (p.47)/ Movie Recorded Pixels (p.48)
- 5 Folder number-File number (p.107)
- 6 Card slot number in use
- 7 Battery level
- 8 Protect (p.86)
- 9 Image transfer status (p.87)
- 10 Store Location Information
- 11 Captured image
- 12 Image edit
- 13 Capture mode (p.48)
- 14 AE Metering (p.59)
- 15 Flash Mode (p.75)
- 16 Crop (p.47)
- 17 JPEG Quality (p.47)/ Framerate (p.48)
- 18 JPEG Recorded Pixels (p.47)
- 19 Color Space (p.47)

- 20 Drive Mode (p.67)
- 21 Number of shots for Interval Shooting/Interval Composite (p.72)
- 22 Total shooting time for Interval Composite (p.73)
- 23 Anti-Aliasing Filter Simulator (p.80)
- 24 Digital Filter (p.77)
- 25 Brightness histogram
- 26 Shake Reduction (p.80)/ Auto Horizon Correction (p.81)
- 27 Lens focal length
- 28 HDR Capture (p.79)/ Clarity (p.80)
- 29 Focus method (p.59)
- 30 Focusing area (AF point) (p.60)
- 31 Distortion Correction (p.79)
- 32 Peripheral Illumination Correction (p.79)
- 33 Diffraction Correction (p.79)
- 34 Highlight Correction (p.78)
- 35 Shadow Correction (p.78)
- 36 Slow Shutter Speed Noise Reduction (p.51)
- 37 High-ISO Noise Reduction (p.58)
- 38 Custom Image (p.76)
- 39 Custom Image parameters
- 40 Shutter speed
- 41 Aperture value
- 42 ISO Sensitivity (p.57)
- 43 EV Compensation (p.53)
- 44 Number of images
- 45 Recording Sound Level (p.48)
- 46 Length of time of the recorded movie
- 47 Photographer (p.110)
- 48 Copyright Holder (p.110)
- 49 Tampered image warning
- 50 Altitude
- 51 Lens direction
- 52 Latitude/Longitude
- 53 Universal Coordinated Time

Memo

- The camera can also display images captured with the K-3 Mark III. For details on the information display, refer to the Operating Manual of the K-3 Mark III.

Using the Touch Panel

You can use the touch panel to select functions, set the AF point for shooting, and perform other operations. (p.50)

When not using the touch panel

function, set [Monitor Touch Operation] to [Off] in the **C3** menu.

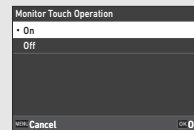

LCD Panel and Viewfinder

The shooting information such as the exposure value is displayed on the LCD panel and in the viewfinder.

LCD Panel

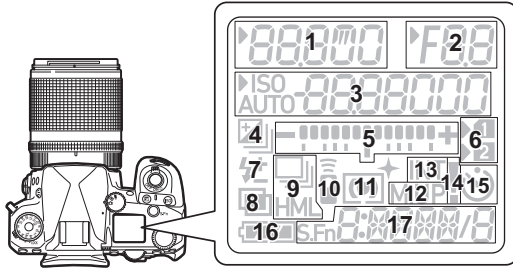

Viewfinder Display

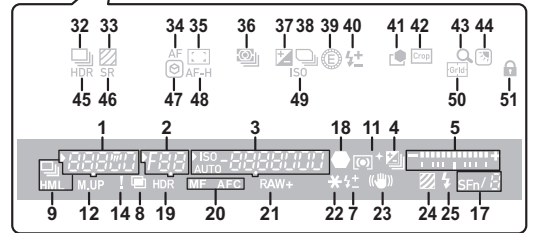
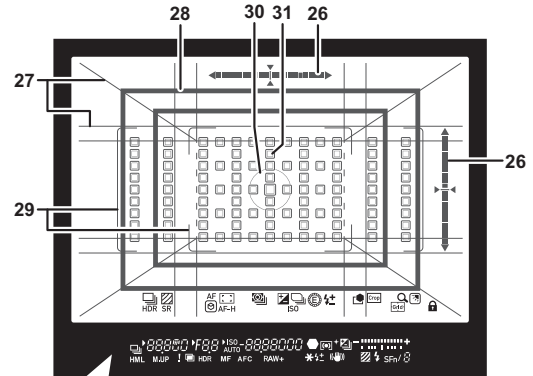

- 1 Shutter speed/ Remaining processing time for Slow Shutter
- 2 Aperture value
- 3 ISO Sensitivity (p.57)/ Exposure compensation value/Image storage capacity/AF Active Area (p.60)
- 4 EV Compensation (p.53)/Bracketing (p.68)
- 5 EV bar scale
- 6 Card slot number
- 7 Flash Exposure
- 8 Multi-exposure (p.71)
- 9 Continuous Shooting (p.68)
- 10 Remote Control (p.74)
- 11 AE Metering (p.59)
- 12 Mirror Up
- 13 Interval Shooting (p.72)

- 14 Warning Display (p.106)
- 15 Self-timer (p.74)
- 16 Battery level
- 17 Smart Function (p.19)
- 18 Focus indicator
- 19 HDR Capture (p.79)
- 20 Focus method (p.59)
- 21 File Format (p.47)
- 22 AE Lock
- 23 Shake Reduction (p.80)
- 24 Anti-Aliasing Filter Simulator (p.80)
- 25 Flash indicator (p.75)
- 26 Electronic level
- 27 Grid display (p.103)
- 28 Cropping frame (p.47)
- 29 AF Frame (p.44)
- 30 Spot Metering Frame (p.59)
- 31 AF point (p.60)
- 32 Drive (p.67)
- 33 Anti-Aliasing Filter Simulator (p.80)
- 34 AF Mode (p.60)
- 35 AF Active Area (p.60)
- 36 AE Metering (p.59)
- 37 EV Compensation (p.53)
- 38 Program Line (p.51)
- 39 E-Dial
- 40 Flash Exposure Compensation
- 41 Custom Image (p.76)
- 42 Crop (p.47)
- 43 Zoom Review
- 44 Outdoor View Setting (p.13)
- 45 HDR Capture (p.79)
- 46 Shake Reduction (p.80)
- 47 Focus Peaking (p.64)
- 48 Hold AF Status (p.61)
- 49 ISO Sensitivity (p.57)
- 50 Grid Guide
- 51 Operation Control Lock (p.45)

Memo

- The LCD panel illumination and the viewfinder display can be changed in [LCD Panel] of the **C4** menu and [Viewfinder Display] of the **C4** menu, respectively. (p.104, p.103)
- No. 1 to 25 for the viewfinder display are the outside-field-of-view information. The outside-field-of-view information is displayed in the viewfinder when **SHUTTER** is pressed halfway, or during the meter operating time (default setting: 10 seconds). To not display the outside-field-of-view information, change the [Info Display Outside FOV] setting in [Viewfinder Display] of the **C4** menu. You can change the meter operating time in [Meter Operating Time] of the **C5** menu. (p.32)
- The functions currently enabled for the Smart Function and their settings are displayed for No. 17 and No. 32 to 50. When **S.Fn** is operated, the icons of registered functions appear, and the icon of the currently selected function blinks. (p.19)
- You can adjust the viewfinder image sharpness using the diopter adjustment dial.

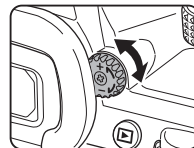

Eye Sensor

The eye sensor detects whether the user is looking through the viewfinder in the standby mode while shooting with the viewfinder. When the sensor detects the user's eye, the monitor backlight turns off and the metering starts.

The setting can be changed in [Eye Sensor] of the **C4** menu. (p.103)

The eye sensor may operate when an object is brought close to it or it is exposed to direct sunlight. It is also used for the automatic brightness adjustment of the monitor. (p.105)

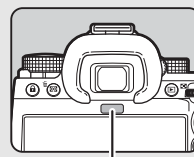

Eye sensor

Electronic Level

The electronic level is displayed on the status screen and Live View and in the viewfinder to check whether the camera is tilted. The horizontal scale shows the horizontal camera angle, and the vertical scale shows the vertical camera angle, in units of 0.5°.

Example of Viewfinder Display

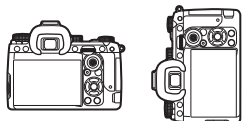

When the camera is level (tilt: 0°)



When the camera is tilted downward to the left by more than 5°



When the camera is held vertically and tilted downward to the right by 3°



Memo

- For the electronic level displayed in the viewfinder, you can hide the vertical camera angle by changing the [Electronic Level Type] setting in [Viewfinder Display] of the **C4** menu. (p.103)

How to Change Function Settings

Most functions are set from the menu. Frequently used functions can also be set by operating buttons, using the Smart Function, or selecting on the control panel. The functions set with the button operation, Smart Function, and control panel can be customized.

Using the Direct Keys

Press **▲▼◀▶** in the standby mode.

By default, the following functions can be set.

| | | |
|----------|-----------------------------|------|
| ▲ | Drive Mode | p.67 |
| ▼ | Outdoor View Setting | p.13 |
| ◀ | Fx | p.98 |
| ▶ | Custom Image | p.76 |

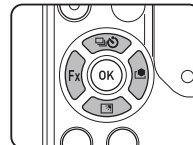

Memo

- The functions of **▲▼◀▶** and other buttons such as **RAW** can be changed in [Fx Button] of the **C2** menu. (p.98)

Using the Smart Function

You can quickly change the settings for the five registered functions while looking through the viewfinder or displaying the Live View.

By default, the following functions can be set.

| Function | Setting Description | Page |
|-------------------|--|----------------|
| User AF | Switches between the settings of [AF Mode], [AF Active Area], and [Hold AF Status] specified in advance. | p.60 |
| E-Dial | Changes the exposure value. | p.49 |
| Drive | Switches between the drive modes of [Drive] in [Drive Mode] specified in advance. | p.67 |
| Crop | Switches between the settings of [Crop] in the  4 menu. | p.47 |
| Grid Guide | Switches between the display patterns specified in advance in [Viewfinder Screen] of [Viewfinder Display] when shooting with the viewfinder. Changes the type of grid displayed on the Live View screen when shooting with Live View. | p.103 p.104 |

1 Press **S.Fn**, and then turn



The function selection changes.

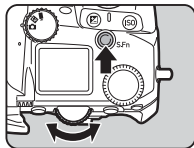

The icons of the settable functions appear in the viewfinder and on the LCD panel.

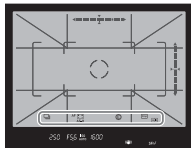

The icon of the selected function blinks.

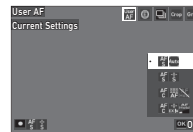

The operation guide is displayed on the status screen and Live View.



Available operations

-  Starts/ends changing the settings.
-  Resets the function setting to the default setting.

2 Turn .

The setting for the selected function changes.

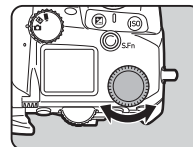

Memo

- The functions set with the Smart Function can be changed in [Smart Function] of the **C2** menu. (p.102)
- The setting of the last selected function can be changed with  in the standby mode.

Using the Control Panel

The shooting functions can be set.

1 Press **INFO** in the standby mode.

The control panel appears.

2 Use **▲▼◀▶** to select a function.

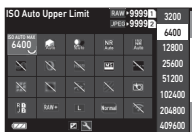

3 Turn **☺** to change the setting.



Available operations



Changes the parameter for the selected function (when detailed settings can be made).



Displays the menu screen for the selected function.



Customizes the control panel.

4 Press **MENU**.

The screen in the standby mode reappears.

Memo

- The functions that can be selected vary depending on the current camera settings.
- The functions displayed on the control panel can be changed by pressing **☑** on the screen of Step 2 or changing the [Control Panel] setting in the **C5** menu. (p.102)

Using the Menu

Most functions can be set from the menus.

1 Press **MENU**.

The menu appears.

2 Turn **☺** to switch the menu type.

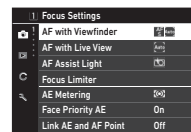

| | |
|----------|--|
| | Still image setting menus (p.22) |
| | In MOVIE mode: Movie setting menus (p.25) |
| | Playback setting menus (p.26) |
| C | Customization menus (p.27) |
| | Setup menus (p.33) |

The menu type can also be switched by pressing **◀** twice, selecting the type with **▲▼**, and pressing **▶** twice.

3 Use **▲▼** to select a function.

Each menu type includes one to eight menus.

Turn **☺** to switch between menus.

4 Find a function to set and press **▶**.

The settings for the selected function are displayed.

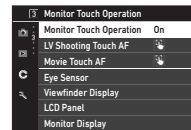

5 Use ▲▼ to select a setting and press **OK**.

The screen of Step 4 reappears. Press **MENU** to return to the previous screen without changing the setting.



6 Press **MENU** several times to return to previous screens.

📌 Memo

- The menu displayed in Step 2 varies depending on the / **LV** / dial setting.
- When **MENU** is pressed, the last used menu screen appears first. To display the most appropriate menu for the camera settings at that time, set [Store Cursor Position] to [Off] in the 2 menu.
- The changed settings remain even after the camera is turned off. For some functions, you can set whether to keep the changed settings in [Memory] of the **C5** menu. (p.107)
- Each menu type can be restored to the default settings in [Reset] of the 8 menu.

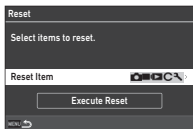

📷 Still Image Setting Menus

| Item | Function | Default Setting | Page |
|---------------------------|--|---|---------------------|
| 📷 1 Focus Settings | | | |
| AF with Viewfinder | AF Mode | Selects the autofocus method for shooting with the viewfinder. | Single AF p.60 |
| | AF Active Area | Sets the AF point for shooting with the viewfinder. | Auto Area p.60 |
| | AF Area Restriction | Limits the range of selectable AF points. | Off p.61 |
| | AF.S Setting | Sets the camera operation priority for when the autofocus mode is set to [Single AF] and SHUTTER is fully pressed. | Focus-priority p.61 |
| | 1st Frame Action in AF.C | Sets the camera operation priority for the first frame when the autofocus mode is set to [Continuous AF] and SHUTTER is fully pressed. | Auto p.61 |
| | Action in AF.C Cont. | Sets the camera operation priority during the continuous shooting when the autofocus mode is set to [Continuous AF]. | Auto p.61 |
| | Hold AF Status | Maintains the focus for a certain amount of time when the subject happens to move out of the selected focusing area after being focused during shooting with [Continuous AF]. | Low p.61 |
| | AF Point for H/V Comp. | Sets whether to memorize the AF point for each composition and the position to which the AF point returns when the AF point selector lever is pushed in. | Common, Center p.61 |
| | Action When AF Fails | Sets the camera operation for when autofocus fails. | Drive Lens p.62 |
| | AF Point Tracking in AF.C | Sets the method for tracking AF points when the autofocus mode is set to [Continuous AF]. | Type 1 p.62 |
| | Subject Recognition | Prioritizes the recognized subject while autofocusing. | On p.62 |
| Catch-in Focus | Enables Catch-in Focus shooting when a manual focus lens is attached. The shutter is released automatically when the subject comes into focus. | Off p.62 | |
| AF with Live View | AF Active Area | Sets the AF active area (AF point) for shooting with Live View. | Auto Area p.63 |
| | Focus Peaking | Emphasizes the outline of the subject in focus and makes it easier to check the focus. | Off p.64 |
| | Contrast AF Options | Sets the camera operation priority for when SHUTTER is fully pressed. | Focus-priority p.64 |

| Item | | Function | Default Setting | Page |
|------------------------------|--------------------------|---|----------------------------------|------|
| AF with Live View | Face Detection | Detects faces and performs autofocus for the detected faces. | On | p.64 |
| AF Assist Light | | Illuminates the assist light when autofocusing in dark locations. | On | p.65 |
| Focus Limiter | | Limits the focusing range for autofocus. | Off | p.65 |
| 📷 2 Exposure Setting | | | | |
| AE Metering | | Selects the part of the sensor to use for measuring brightness and determining the exposure. | Multi-segment | p.59 |
| Face Priority AE | | Adjusts the exposure value by giving priority to the detected faces when [AE Metering] is set to [Multi-segment]. | On | p.59 |
| Link AE and AF Point | | Adjusts the exposure value according to the brightness of the AF point. | Off | p.59 |
| ISO Sensitivity Setting | ISO Auto Upper Limit | Sets the ISO sensitivity upper limit for ISO Auto. | 6400 | p.57 |
| | ISO Auto Lower Limit | Sets the ISO sensitivity lower limit for ISO Auto. | 200 | |
| | Min. Shutter Speed Op. | Sets whether to set the minimum shutter speed automatically or manually. | Auto | |
| | ISO Auto with Min. Speed | Sets how to increase the sensitivity. | Standard | |
| | Minimum Shutter Speed | Sets the shutter speed at which the ISO sensitivity is increased when [Min. Shutter Speed Op.] is set to [Shutter Speed Control]. | 1/125 | |
| Flash Mode | | Sets the flash mode. | Flash On or Auto Flash Discharge | p.75 |
| Program Line | | Selects the Program Line setting. | Standard | p.51 |
| Auto EV Compensation | | Automatically compensates the exposure when the correct exposure cannot be achieved with the current settings. | Off | p.50 |
| 📷 3 Shooting Settings | | | | |
| Shutter Mode Selection | | Switches between the mechanical shutter and the electronic shutter. | Mechanical Shutter | p.54 |
| Drive Mode | Drive | Selects the drive mode. | Single Frame Shooting | p.67 |
| | Timer/Remote Control | Sets whether to use the self-timer and remote control functions. | Off | p.74 |
| AA Filter Simulator | | Applies a low-pass filter effect using the Shake Reduction mechanism. | Off | p.80 |

| Item | | Function | Default Setting | Page |
|-----------------------------------|---------------------------|---|--------------------------|-------|
| HDR Capture | HDR Capture | Makes settings for high dynamic range shooting. | Off | p.79 |
| | Bracket Value | | ±2.0EV | |
| | Auto Align | | On | |
| ASTROTRACER | ASTROTRACER | Makes settings to track and capture celestial bodies. | Off | p.117 |
| | Precise Calibration | Performs a calibration. | — | |
| 📷 4 Image Capture Settings | | | | |
| Memory Card Options | Memory Card Options | Sets the recording method for when two memory cards are inserted. | Sequential Use | p.47 |
| | Card Slot Sequence | Selects one of the memory cards inserted in the SD1 and the SD2 slots to use when [Memory Card Options] is set to [Sequential Use]. | SD1 | |
| File Format | | Sets the file format of images. | JPEG | p.47 |
| Crop | | Sets the angle of view for shooting. | Off | |
| JPEG Recorded Pixels | | Sets the recording size of JPEG images. | <input type="checkbox"/> | |
| JPEG Quality | | Sets the quality of JPEG images. | Super Fine | |
| RAW File Format | | Sets the RAW file format. | PEF | |
| Color Space | | Sets the color space to use. | sRGB | |
| 📷 5 Image Process Settings | | | | |
| Custom Image | | Sets the image finishing tone including sharpness and contrast. | Standard | p.76 |
| Digital Filter | | Applies a digital filter effect when taking images. | Off | p.77 |
| Clarity | | Changes the clarity of images using an image processing function. | ±0 | p.80 |
| Lens Correction | Distortion Correction | Reduces distortions occurring due to lens properties. | Off | p.79 |
| | Peripheral Illumin. Corr. | Reduces peripheral light fall-off occurring due to lens properties. | Off | |
| | Diffraction Correction | Corrects blur caused by diffraction when using a small aperture. | On | |
| D-Range Correction | Highlight Correction | Expands the dynamic range and prevents overexposed areas from occurring. | Auto | p.78 |
| | Shadow Correction | Expands the dynamic range and prevents underexposed areas from occurring. | Auto | |
| Noise Reduction | Slow Shutter Speed NR | Sets the noise reduction setting when shooting with a slow shutter speed. | Auto | p.51 |

| Item | | Function | Default Setting | Page |
|--------------------------|--------------------------|---|--------------------|------|
| Noise Reduction | High-ISO Noise Reduction | Sets the noise reduction setting when shooting with a high ISO sensitivity. | Auto | p.58 |
| | Custom Options | Sets the noise reduction level for each ISO sensitivity setting for [High-ISO Noise Reduction]. | Medium | |
| 6 Shooting Assist | | | | |
| Shake Reduction | | Activates the Shake Reduction function. | Auto | p.80 |
| Auto Shake Reduction Off | | Automatically sets the Shake Reduction function to [Off] when [Self-timer] or [Remote Control] is used. | Enable Auto SR Off | p.80 |
| Auto Horizon Correction | | Corrects horizontal tilt during still image shooting. | Off | p.81 |
| Composition Adjustment | | Allows you to adjust the composition of your image using the Shake Reduction mechanism. | Off | p.81 |

Movie Setting Menus

| Item | | Function | Default Setting | Page |
|---------------------------------|----------------|--|-----------------|------|
| 1 Focus Settings | | | | |
| AF with Live View | AF Active Area | Sets the AF active area (AF point). | Auto Area | p.63 |
| | Movie Mode AF | Sets the autofocus operation in Movie Mode . | Continuous AF | p.55 |
| | Focus Peaking | Emphasizes the outline of the subject in focus and makes it easier to check the focus. | Off | p.64 |
| AF Assist Light | | Illuminates the assist light when autofocusing in dark locations. | On | p.60 |
| Focus Limiter | | Limits the focusing range for autofocus. | Off | p.65 |
| 2 Exposure Setting | | | | |
| AE Metering | | Selects the part of the sensor to use for measuring brightness and determining the exposure. | Multi-segment | p.59 |
| Link AE and AF Point | | Sets whether to link the exposure value and the AF point in the focusing area. | Off | p.59 |
| 3 Shooting Settings | | | | |
| Remote Control | | Sets whether to use the remote control function. | Off | p.74 |
| 4 Movie Capture Settings | | | | |
| Memory Card Options | | Selects one of the memory cards inserted in the SD1 and the SD2 slots for recording movies. | SD1 | p.47 |

| Item | Function | Default Setting | Page | |
|-----------------------------------|---|---|------|------|
| Recorded Pixels | Sets the number of recorded pixels of the movie. | [4K] | p.48 | |
| Framerate | Sets the number of framerate of the movie. | 30p | | |
| Recording Sound Level | Sets the sound volume level for recording. | Auto | | |
| Wind Noise Reduction | Reduces wind noise. | On | | |
| Headphone Volume | Sets the sound volume when a headphone is connected. | 20 | | |
| ■ 5 Image Process Settings | | | | |
| Custom Image | Sets the image finishing tone including sharpness and contrast. | Standard | p.76 | |
| Digital Filter | Applies a digital filter effect when recording movies. | Off | p.77 | |
| D-Range Correction | Highlight Correction | Expands the dynamic range and prevents overexposed areas from occurring. | Auto | p.78 |
| | Shadow Correction | Expands the dynamic range and prevents underexposed areas from occurring. | Auto | |
| ■ 6 Shooting Assist | | | | |
| Shake Reduction | Activates the Shake Reduction function. | On | p.80 | |
| Auto Shake Reduction Off | Automatically sets the Shake Reduction function to [Off] when [Remote Control] is used. | Enable Auto SR Off | p.80 | |



▶ Playback Setting Menus



















| Item | Function | Default Setting | Page |
|---------------------------------|---|-----------------|------|
| ▶ 1 Playback Settings | | | |
| Select Playback Card | Selects one of the memory cards inserted in the SD1 and the SD2 slots for playing back images. | SD1 | p.82 |
| Auto Image Rotation | Rotates images which were captured with the camera held vertically or of which the rotation information has been changed. | On | |
| Playback Order Options | Sets the image display order during playback. | File No. | |
| Playback Sound Volume | Sets the sound volume during movie playback. | 20 | |
| Touch Img. Browse Effect | Sets whether to use the screen effect when the previous or next image is displayed by touch operation. | On | |
| ▶ 2 File Management | | | |
| Delete | Deletes images. | — | p.85 |







| Item | Function | Default Setting | Page |
|--------------------------------|---|-----------------|------|
| Protect | Protects images from being accidentally erased. | — | p.86 |
| Image Rotation | Changes the rotation information of an image. | — | p.86 |
| Image Copy | Copies images between cards in the SD1 and the SD2 slots. | — | p.87 |
| File Transfer | Sets the transfer reservation for images to transfer to a communication device. | — | p.87 |
| Save RAW Data | Saves the RAW data of a captured JPEG image. | — | p.88 |
| ▶ 3 RAW/JPEG Image Edit | | | |
| Digital Filter | Processes images with digital filters. | — | p.88 |
| Cropping | Crops out only the desired area of an image. | — | p.91 |
| ▶ 4 RAW Image Edit | | | |
| RAW Development | Develops RAW images into JPEG images and saves them as new files. | — | p.89 |
| ▶ 5 JPEG Image Edit | | | |
| Resize | Changes the number of recorded pixels of an image. | — | p.90 |
| Levels Adjustment | Adjusts the brightness and contrast of the highlight, mid-tone, and shadow areas in images. | — | p.91 |
| ▶ 6 Movie Edit | | | |
| Extract Movie | Saves the range specified with the start and end points as a new file. | — | p.92 |
| Divide Movie | Divides a movie into two files at the specified division point and saves as new files. | — | |







C Customization Menus

| Item | Function | Default Setting | Page |
|---------------------------------|--|-----------------|------|
| C1 User Mode | | | |
| Save User Mode Settings | Saves frequently used capture settings in up to ten setting boxes. | — | p.96 |
| Rename User Mode | Changes the name of a setting box. | — | |
| Recall User Mode Setting | Assigns the saved settings to U1 to U5 of the mode dial. | — | |
| Reset User Mode Settings | Resets the settings saved in a setting box. | — | |

| Item | Function | Default Setting | Page | |
|----------------------------------|---|--|--------------------------|-------|
| Exposure in User Mode | Temporarily changes the exposure mode when the mode dial is set to one of the modes from U1 to U5 . | P | p.97 | |
| User Settings Restoration | Set the timing to restore the settings saved in the user mode. | Type 1 | p.97 | |
| C2 Customize Controls | | | | |
| Fx Button | Shake Reduction Button | Customizes the button functions. | Shake Reduction | p.98 |
| | RAW Button | | One Push File Format | |
| | Operation Lock Button | | Operation Control Lock | |
| | AE Metering Button | | AE Metering | |
| | Playback Button | | Playback Mode | |
| | AE Lock Button | | AE Lock | |
| | Up Button | | Drive Mode | |
| | Down Button | | Outdoor View Setting | |
| | Left Button | | Unset | |
| | Right Button | | Custom Image | |
| | One Push File Format | Sets the file format to change to with the One Push File Format function. | RAW+JPEG, On | |
| | Crop | Sets the Crop setting switching pattern when the button is pressed. | OFF→1.3x→1.7x | |
| | Shake Reduction | Sets the Shake Reduction operation switching pattern when the button is pressed. | OFF→AUTO→PAN | |
| | Operation Control Lock | Sets the type of buttons to lock the operation when the button is pressed. | Exposure Change Lock | |
| AF/AE Lock Settings | Still Image | Sets the autofocus operation when SHUTTER is pressed halfway or AF is pressed in  mode. | Enable AF, Enable AF Off | p.100 |
| | Movie | Sets the autofocus operation when SHUTTER is pressed halfway in  mode. | Enable AF | p.55 |

| Item | | Function | Default Setting | Page | |
|--------------------|--|--|--|---|-------|
| Preview Dial | Preview Method | Sets the camera operation for when the main switch is turned to the  position. | Optical Preview | p.66 | |
| | Digital Preview Settings | Sets the functions to use during Digital Preview. | All On | | |
| E-Dial Programming | Still Image | Sets the  /  /  operation for each exposure mode. | P | Tv HYPER, Av HYPER, ➔P , ISO | p.100 |
| | | | Sv | Off, ISO, —,  | |
| | | | Tv | Tv , Off, —, ISO | |
| | | | Av | Off, Av , —, ISO | |
| | | | TAv | Tv , Av , —,  | |
| | | | M | Tv , Av , P LINE, ISO | |
| | | | B | Off, Av , Timed exposure, ISO | |
| | | | X | Off, Av , —, ISO | |
| | Movie | Sets the  /  /  operation for each exposure mode. | P | Off, Off, —,  | |
| | | | Tv | Tv , Off, —,  | |
| | | | Av | Off, Av , —,  | |
| | | | TAv | Tv , Av , —,  | |
| | | M | Sets the  /  /  operation for each exposure mode. | Tv , Av , P LINE, ISO | |
| | Rotation Direction | Reverses the effect obtained when  or  is turned. | Rotate Right | p.101 | |
| HYPER P/Sv Options | Sets the camera operation when the camera enters the Hyper mode in P or Sv mode. | Standard | p.101 | | |



| Item | | Function | Default Setting | Page |
|-----------------------------------|--------------------------|---|-----------------|-------|
| Smart Function | Function 1 | Registers the functions to use with the Smart Function. | User AF | p.102 |
| | Function 2 | | E-Dial | |
| | Function 3 | | Drive | |
| | Function 4 | | Crop | |
| | Function 5 | | Grid Guide | |
| One Push ISO Auto | | Resets to ISO Auto with ISO without displaying the setting screen when the ISO sensitivity can be changed with  ,  , and  . | Off | p.57 |
| One Push Exposure Reset | | Resets the compensation value with 2 when the exposure can be compensated with  ,  , and  . | Off | p.53 |
| C3 Monitor Touch Operation | | | | |
| Monitor Touch Operation | | Sets whether to use the touch panel function to operate the camera. | On | p.15 |
| LV Shooting Touch AF | | Sets the camera operation when Touch AF is performed during shooting with Live View. | AF Point | p.50 |
| Movie Touch AF | | Sets the camera operation when Touch AF is performed during movie recording. | AF Point | p.55 |
| C4 Display Customization | | | | |
| Eye Sensor | Link Monitor Display | Turns off the monitor backlight when the eye sensor detects the user's eye. | On | p.103 |
| | AE with Eye Sensor | Starts metering when the eye sensor detects the user's eye. | Off | |
| | Detection Sensitivity | Sets the eye sensor detection sensitivity. | Medium | |
| Viewfinder Display | Viewfinder Screen | Sets the display in the viewfinder. | F1 | p.103 |
| | Electronic Level Type | Displays the electronic level in the viewfinder. | Level+Tilt | |
| | Viewfinder Light | Sets whether to light up the viewfinder when focusing the subject or changing the focusing area. | Auto | |
| | Info Display Outside FOV | Displays information at the bottom outside the field of view in the viewfinder. | On | |
| LCD Panel | Illumination Brightness | Sets the brightness of the LCD panel. | High | p.104 |
| | LCD Panel Illumination | Sets the illumination method of the LCD panel. | Auto | |

| Item | Function | Default Setting | Page |
|----------------------------------|--|--|----------------------------------|
| Monitor Display | Color Settings | Sets the display color and style of the status screen, control panel, and menu cursor. | Color: 01, Style: 1 |
| | Status Screen | Sets the status screen display. | On, On, Level+Tilt, Type 1 |
| | Live View | Sets the information to display when the style of the display is switched with  during shooting with Live View. | L1, Level+Tilt, Type 1, 50Hz |
| | Playback Info Display | Sets the information to display when the screen is switched with  in the playback mode. | All Off |
| | Grid Guide | Sets the type and color of grid lines. | 4x4 Grid, Black |
| Instant Review | Display Time | Sets the Instant Review display time. | 1sec. |
| | Zoom Review | Displays the magnified image with  during Instant Review. | On |
| | Save RAW (RAW Button) | Saves the RAW data with  during Instant Review. | On |
| | Delete Img. (Delete Btn.) | Deletes the displayed image with  during Instant Review. | On |
| | Manage Img. (AE-L Btn.) | Displays the file management screen with  during Instant Review. | On |
| | Histogram | Displays the histogram during Instant Review. | Off |
| | Highlight Alert | Sets overexposed areas to blink red during Instant Review. | Off |
| Zoom Review | Quick Zoom | Sets the display magnification and trigger operation for the quick zoom function during Instant Review. | 100% |
| | Focus Magnification | Zooms the display centering on the focused point. | On |
| Warning Display | Release Lock Warning | Displays the warning icon when the shutter cannot be released. | On |
| | Release Timer Warning | Displays the warning icon when the shutter cannot be released immediately because [Self-timer] or [Remote control] is used. | On |
| | Image Processing Warning | Displays the warning icon when the image processing takes a long time after shooting. | On |
| C5 Function Customization | | | |
| Control Panel | Customizes the functions displayed on the control panel. | — | p.102 |

| Item | Function | Default Setting | Page |
|----------------------------------|---|-----------------|-------|
| Memory | ISO Sensitivity | On | p.107 |
| | EV Compensation | On | |
| | Flash Mode | On | |
| | Flash Exposure Comp. | On | |
| | Drive | On | |
| | Timer/Remote Control | On | |
| | HDR Capture | Off | |
| | Crop | On | |
| | Custom Image | On | |
| | Digital Filter | Off | |
| | Clarity | Off | |
| | Composition Adjustment | On | |
| | Shooting Info Display | On | |
| | Playback Info Display | On | |
| | Image for Playback | Off | |
| | Operation Control Lock | On | |
| | Outdoor View Setting | Off | |
| Night Vision Display | Off | | |
| Focus Limiter | Off | | |
| EV Steps | Sets the adjustment steps for the exposure. | 1/3 EV Steps | p.50 |
| ISO Sensitivity Steps | Sets the adjustment steps for the ISO sensitivity. | 1 EV Step | p.57 |
| Meter Operating Time | Sets the time to continue metering after it is started. | 10sec. | p.17 |
| Bulb (B) Mode Options | Sets the camera operation when SHUTTER is pressed in B mode. | Bulb | p.52 |
| X Mode Sync Speed | Sets the flash sync speed. | 1/200 | p.116 |
| C6 Function Customization | | | |
| AF with Remote Control | Sets whether to use autofocus when shooting with the remote control unit. | Off | p.75 |
| MF Lens Focal Length | Sets the focal length when using a lens of which focal length information cannot be obtained. | 35mm | p.115 |

| Item | Function | Default Setting | Page |
|--------------------------------|---|-----------------|-------|
| Length Input on Startup | Sets whether to input the focal length when the camera is turned on with a lens of which focal length information cannot be obtained. | On | p.115 |
| Save Rotation Info | Sets the angle recorded as rotation information in captured images. | Auto | p.86 |
| Using Aperture Ring | Releases the shutter even when the lens aperture ring is set to a position other than A (Auto). | Off | p.114 |
| Aperture Info Record | Records the manually input aperture value in captured images when the lens aperture value cannot be obtained. | Off | p.114 |
| AF Fine Adjustment | Precisely fine-tunes lenses with the camera's autofocus system. | Off | p.65 |

Setup Menus

| Item | Function | Default Setting | Page |
|--|--|---|-------|
|  1 File Setting | | | |
| Format | Formats a memory card. | — | p.42 |
| Create New Folder | Creates a new folder on the memory card. | — | p.107 |
| Folder Name | Sets the folder name in which images are stored. | Date | p.108 |
| File Name | Sets the file name assigned to an image. | IMGP | p.109 |
| Sequential Numbering | Continues the sequential numbering for the file name when a new folder is created. | Folder & File | p.109 |
| Reset Numbering | Resets the file number setting and returns to 0001 each time a new folder is created. | — | p.109 |
| Copyright Information | Sets the photographer and copyright information embedded in the Exif data. | Off | p.110 |
|  2 Monitor Settings | | | |
| Store Cursor Position | Saves the last menu displayed on the monitor and displays it again the next time MENU is pressed. | On | p.21 |
| Guide Display | Displays the setting change status when the Fx button is operated. | On | p.99 |
| Monitor Adjustment | Adjusts the brightness, saturation, and color tone of the monitor. | Brightness: Auto Brt. Adj., Others: 0 | p.105 |

| Item | Function | Default Setting | Page | |
|---------------------------------|---|--|-------|------------------------------|
| Outdoor View Setting | Adjusts the brightness of the monitor for outdoor shooting. | Off | p.13 | |
| Night Vision Display | Changes the monitor display color to red for shooting at night or in a dark place. | Off | p.118 | |
| Exp. Simulation LV | Adjusts the screen brightness according to the exposure setting when shooting with Live View. | On | p.50 | |
| 3 Lamp/Sound Settings | | | | |
| Indicator Lamps | Self-timer | Sets whether to light up the self-timer lamp when shooting with the self-timer. | On | p.106 |
| | Remote Control | Sets whether to light up the self-timer lamp when shooting with the remote control unit. | On | |
| | GPS Unit | Sets whether to light up the lamps when the GPS unit is attached to the camera. | On | |
| Sound Effects Volume | | Sets the sound volume of beep sounds. | 3 | p.106 |
| Sound Effects Setting | Electronic Shutter Sound | Makes a shutter sound while shooting with the electronic shutter. | On | |
| | In-focus | Makes a beep sound when the subject is focused. | On | |
| | AE Lock | Makes a beep sound when the exposure value is locked. | On | |
| | Count Down | Makes a beep sound during the countdown for shooting with the self-timer or remote control unit (shutter release after 3 seconds). | On | |
| | Mirror Up | Makes a beep sound during the mirror lock-up shooting. | On | |
| Fx Button Operation | Makes a beep sound when the Fx button is operated. | On | | |
| 4 Communication Settings | | | | |
| USB Setting | | Sets the USB connection mode when connecting to a computer. | MTP | p.93 |
| Bluetooth Setting | Action Mode | Sets whether to use the Bluetooth® communication function. | Off | Separate guide ^{*1} |
| | Pairing | Performs pairing between the camera and a communication device. | — | |
| | Communication Info. | Displays [Device Name] of the camera. | — | |
| Wireless LAN Setting | Action Mode | Sets whether to use the wireless LAN communication function. | Off | |
| | Communication Info. | Displays [SSID], [Password], and [MAC Address] of the camera. | — | |

| Item | | Function | Default Setting | Page |
|---------------------------------|---------------------------------|--|-----------------|------------------------------|
| Smartphone Link | Store Location Info. | Records the location information of the communication device in captured images. | Off | Separate guide ^{*1} |
| | Auto Image Transfer | Automatically transfers captured images to the communication device after shooting. | Off | |
| | Auto Resize | Reduces the number of recorded pixels of images before transferring them. | Off | |
| | Image Transfer while Off | Continues the image transfer even when the camera is turned off midway through the transfer. | Off | |
| GPS Settings | | Performs a calibration of electronic compass information when the optional GPS unit is attached to the camera. | — | p.117 |
| 5 Power Supply Settings | | | | |
| Auto Power Off | | Sets the time until the camera turns off automatically if no operations are made for a certain period of time. | 1min. | p.41 |
| Power Saving Mode | | Controls the display time of the status screen to reduce battery consumption. | High | p.39 |
| Battery Grip Settings | | Sets the camera operation for when the optional battery grip is attached to the camera. | Auto | p.38 |
| USB Power Supply to Ext. | | Supplies power to an external device via the USB cable. | — | p.39 |
| 6 Maintenance | | | | |
| Firmware Info/Options | | Displays the camera's firmware version. You can check the current firmware version before running an update. | — | — |
| Certification Marks | | Displays the certification marks of conformance to wireless technical standards. | — | Separate guide ^{*1} |
| Pixel Mapping | | Maps out and corrects defective pixels on the sensor. | — | p.120 |
| Dust Removal | | Cleans the sensor by applying high-frequency (ultrasonic) vibrations. | On, On | p.120 |
| Sensor Cleaning | | Locks the mirror in the up position for cleaning the sensor with a blower. | — | p.121 |
| 7 Language/Date Setting | | | | |
| Language/言語 | | Changes the display language. | English | p.42 |
| Date Adjustment | | Sets the date and time and the display format. | 01/01/2023 | p.42 |
| 8 Reset | | | | |
| Reset | | Resets the settings of the direct keys, Smart Function, menu items, and control panel items. | — | p.21 |

*1 See RICOH IMAGING website for details.

Attaching the Strap

- 1 Pass the end of the strap through the triangular ring.

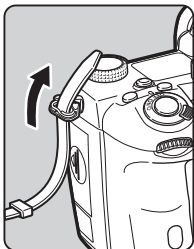

- 2 Secure the end of the strap on the inside of the clasp.

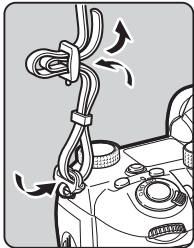

When the Battery Grip is Used

When the optional Battery Grip D-BG8 is used, you can attach one end of the strap to the battery grip.

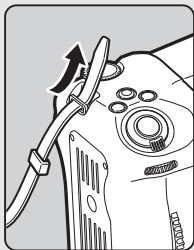

Attaching a Lens

- 1 Make sure that the camera is turned off.
- 2 Remove the body mount cap (1) and lens mount cover (2).
Turn the body mount cap counterclockwise while pressing the lens unlock button (3). After removing the cover, be sure to put the lens down with the lens mount side facing upward.
- 3 Align the lens mount indexes (red dots: 4) on the camera and the lens, and secure by turning the lens clockwise until it clicks.

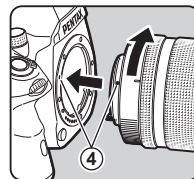
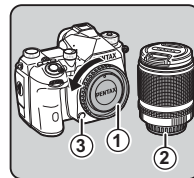

To remove the lens

Attach the lens cap, and then turn the lens counterclockwise while pressing the lens unlock button.

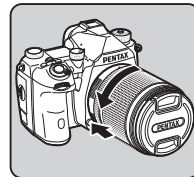

⚠ Caution

- When attaching or removing the lens, choose an environment that is relatively free of dirt and dust.
- Keep the body mount cap attached on the camera when a lens is not attached.
- Be sure to attach the lens mount cover and lens cap to the lens after removing it from the camera.
- Do not insert your fingers inside the lens mount of the camera or touch the mirror.
- The camera body and lens mount incorporate lens information contacts. Dirt, dust, or corrosion may damage the electrical system. Please contact your nearest service center for professional cleaning.
- When a retractable lens is attached and is not extended, you cannot take images or use some functions. If the lens is retracted during shooting, the camera stops working. Refer to “How to Use a Retractable Lens” (p.45) for details.
- We assume no responsibility nor liability for accidents, damages, and malfunctions resulting from the use of lenses made by other manufacturers.

📄 Memo

- Refer to “Functions Available with Various Lenses” (p.112) for details on the functions of each lens.

Using the Battery and Charger

Use the battery D-LI90 exclusively developed for this camera.

Inserting/Removing the Battery

⚠ Caution

- Insert the battery correctly. If the battery is inserted incorrectly, it may not be removed.
- Wipe the electrodes of the battery with a soft dry cloth before inserting.
- Do not remove the battery while the power is on.
- Be careful as the camera or battery may become hot after the camera has been used continuously for a long period of time.
- Remove the battery when you do not use the camera for a long period of time. The battery may leak and damage the camera if left installed during prolonged periods of non-use. If the removed battery is not used for six months or longer, charge the battery for about 30 minutes before storing it. Be sure to recharge the battery every six to twelve months.
- Store the battery in a location where the temperature will remain at or below room temperature. Avoid locations with high temperatures.
- The date and time may be reset if you leave the battery out of the camera for long periods of time. If this happens, set the current date and time again.

1 Open the battery cover.

Lift the battery cover unlock knob, turn it towards OPEN to unlock, and then pull the cover open.

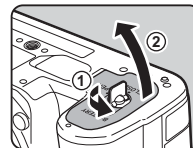

- 2** Face the ▲ mark on the battery towards the outside of the camera, and insert the battery until it locks into place.

To remove the battery, push the battery lock lever in the direction of ③.

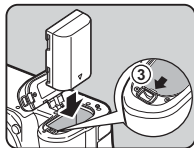

- 3** Close the battery cover.

Turn the battery cover unlock knob towards CLOSE to lock, and then put it down.

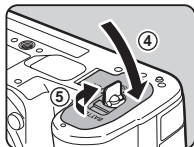

Memo

- The battery level may not be displayed properly if the camera is used at low temperatures or when performing continuous shooting for a long time.
- Battery performance temporarily decreases as the temperature decreases. When using the camera in cold climates, have extra batteries at hand and keep them warm in your pocket. Battery performance will return to normal at room temperature.
- Have extra batteries ready when traveling overseas or taking a lot of images.
- When the optional Battery Grip D-BG8 is used, you can set the priority order of battery use in [Battery Grip Settings] of the 5 menu.

Charging the Battery

- 1** Insert the power plug into the USB power adapter until it clicks.

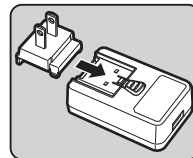

- 2** Connect the USB cable to the USB power adapter.

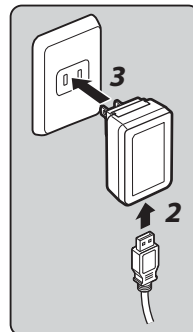

- 3** Plug the USB power adapter into the power outlet.

- 4** Make sure that the main switch of the camera is set to [OFF], and open the terminal cover.

- 5** Connect the USB cable to the USB terminal.

The self-timer lamp on the back of the camera turns on while charging (blinks once at intervals of 5 seconds), and turns off when the battery is fully charged.

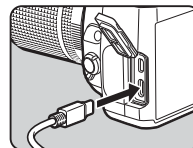

⚠ Caution

- If the camera is turned on while charging, the charging stops.
- If the self-timer lamp continues to blink rapidly, make sure that the main switch is set to [OFF], remove the USB cable and battery from the camera, and start over from the beginning. If this does not improve the situation, contact your nearest service center.
- If the battery starts to run down more quickly even after being charged, the battery may have reached the end of its service life. Replace the battery with a new one.

📝 Memo

- The maximum charging time is approximately 4.5 hours (it depends on temperature and remaining battery power). Charge the battery in a location where the temperature is between 10°C and 40°C (50°F and 104°F).
- You can also charge the battery by connecting the camera to a computer using the USB cable and turning the camera off. (p.93)
- You can also charge the battery using the optional Battery Charger D-BC177.
- When the optional Battery Grip D-BG8 is used, you can charge the battery in the battery grip. The battery set in [Battery Grip Settings] of the  5 menu of the camera is charged first. The self-timer lamp blinks twice continuously while charging the battery in the camera, and three times continuously while charging the battery in the battery grip.
- You can also charge the battery by connecting a commercial portable charger to the camera with a USB cable.

Supplying Power to Another Device

You can supply power to another device using the battery of the camera via a USB cable. Select [Execute] in [USB Power Supply to Ext.] of the  5 menu, and turn the camera off. This function cannot be used if the battery level is insufficient.

Power Saving Mode

The battery consumption can be reduced by controlling the display time of the status screen. Make settings in [Power Saving Mode] of the  5 menu.

| | |
|------|--|
| Low | Turns the monitor off when the time set in [Meter Operating Time] of the C5 menu elapses. |
| High | Performs metering for 2 seconds after Instant Review during shooting, and turns the monitor off. (Default setting) |
| Off | Keeps the monitor on even after the metering time elapses. |

Using the AC Adapter

We recommend the use of the optional AC Adapter Kit K-AC166 when using the camera for a long time.

1 Connect the AC adapter to the AC plug cord, and plug the cord into the power outlet.

2 Make sure that the camera is turned off, and open the terminal cover.

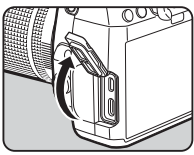

3 Connect the USB Type-C cable of the AC adapter to the USB terminal of the camera.

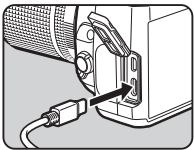

Caution

- Make sure that the camera is turned off before connecting or disconnecting the AC adapter.
- Make sure that the connections are secure between the terminals. The memory card or data may be corrupted if the connection to the power supply is lost while the card is being accessed.
- Be sure to read the manual of the AC adapter kit before using the AC adapter.

Inserting a Memory Card

The following memory cards can be used with this camera.

- SD Memory Card
- SDHC Memory Card
- SDXC Memory Card

In this manual, these cards are referred to as memory cards.

1 Make sure that the camera is turned off.

2 Slide the memory card cover in the direction of ①, and then rotate it to open as shown by ②.

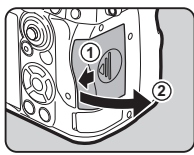

3 Insert a card all the way into each memory card slot with the memory card label facing toward the side with the monitor.

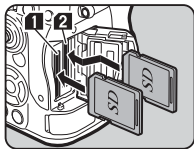

Push the memory card in once and release to remove.

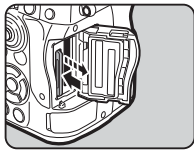

- 4 Rotate the memory card cover as shown by ③, and slide it in the direction of ④.

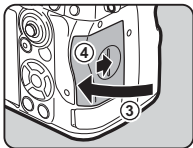

⚠ Caution

- When inserting a memory card into the memory card slot, insert it straight. Inserting the memory card at an angle or applying excessive force may damage the card or memory card slot.
- Do not remove the memory card while the card access lamp is lit.
- If the memory card cover is opened while the power is on, the camera turns off. Do not open the cover while the camera is in use.
- Use this camera to format (initialize) a memory card that is unused or has been previously used on other devices. (p.42)
- Use a high-speed memory card when recording movies. If the writing speed cannot keep up with the recording speed, writing may stop during recording.

📄 Memo

- For details on how the data is recorded when two memory cards are inserted, refer to “Memory Card Recording Settings” (p.47).
- Memory cards compatible with the UHS-I/UHS-II standard can be used. However, if an UHS-II memory card is inserted in the SD2 slot, it operates at a speed equivalent to UHS-I.

Initial Settings

Turn the camera on and make the initial settings.



Turning the Camera On

- 1 Turn the main switch to [ON].

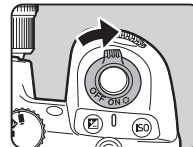
The first time the camera is turned on after purchase, the [Language/言語] screen appears.



📄 Memo

- The power automatically turns off when you do not perform any operations within a set period of time. (Default setting: 1min.) You can change the setting in [Auto Power Off] of the  5 menu. The camera recovers from Auto Power Off when **SHUTTER** or  is pressed.

Setting the Display Language, Date and Time, and Color

1 Use ▲▼ to select the desired language in the [Language/言語] screen, and press **OK**.

The selected language is set and the [Date Adjustment] screen appears.

2 Set the display format and the date and time.

Use ◀▶ to select an item and ▲▼ to change the value.

Press **MENU** to cancel the setting.

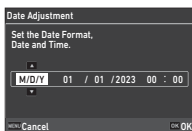

3 Press **OK**.

The date and time are set and the [Color Settings] screen appears.

4 Make settings for [Color] and [Style].

Use ◀▶ to select an item and ▲▼ to change the value.

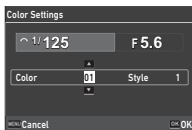

| | |
|--------------|--|
| Color | Sets the display color of the status screen, control panel, and menu cursor. |
| Style | Sets the style of the status screen and control panel. |

5 Press **OK**.

The camera switches to the capture mode and is ready to take an image.

🔍 Memo

- You can change the settings of the display language and date and time in the **7** menu, and the display color in [Color Settings] of [Monitor Display] in the **C4** menu. (p.35, p.104)

Formatting a Memory Card



1 Press **MENU**.

The menu appears.

2 Turn to select .

3 Select [Format] and press **▶**.

The [Format] screen appears.

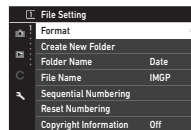

4 Use ▲▼ to select the memory card slot in which the memory card to format is inserted and press **▶**.

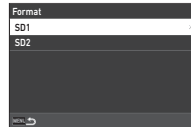

5 Use ▲ to select [Execute] and press **OK**.

Formatting starts. When formatting is completed, the screen of Step 4 reappears.

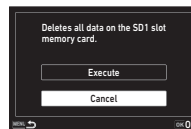

6 Press **MENU** twice.

The screen in the capture mode reappears.

⚠ Caution

- Do not remove the memory card while formatting, or the card may be damaged.
- Formatting deletes all data, both protected and unprotected.

📄 Memo

- When a memory card is formatted, the volume label "K-3 IIIM" is assigned to the card.

Basic Shooting Operation

Take images in **AUTO** (Scene Analyze Auto) mode in which the camera analyzes shooting conditions and automatically sets the optimal shooting settings.

Shooting with the Viewfinder

- 1 Remove the front lens cap by pushing the top and bottom portions as indicated in the illustration.

When a retractable lens is attached, extend the lens before turning the camera on.

 How to Use a Retractable Lens (p.45)

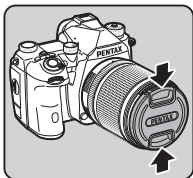

- 2 Turn the camera on.

- 3 Set the /LV// dial to .

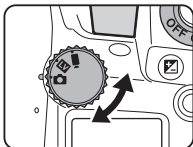

- 4 Set the focus method switch to **AF**.

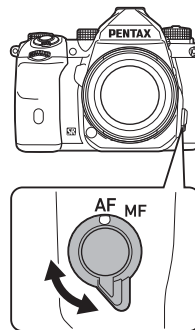

- 5 Set the mode dial to **AUTO** while pressing the mode dial lock button.

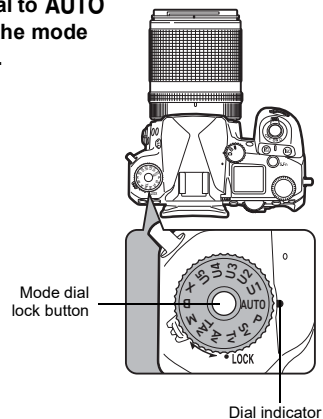

You can release the mode dial lock using the mode dial lock release lever to easily operate the mode dial without having to press the mode dial lock button.

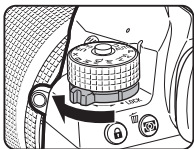

The selected capture mode is displayed on the monitor.



6 Look through the viewfinder to view the subject.

When using a zoom lens, turn the zoom ring to the right or left to change the angle of view.

7 Position the subject inside the AF frame and press **SHUTTER** halfway.

Autofocus is performed.

The focus indicator (●) appears and you will hear a beep when the subject comes into focus.

🔊 Sound Effects settings (p.106)



8 Press **SHUTTER** fully.

The captured image is displayed on the monitor (Instant Review).

Available operations during Instant Review

| | |
|--------------------------|--|
| | Deletes the image. |
| to the right / OK | Magnifies the image. Use + to change the area to display. |
| RAW | Saves the RAW data (only when a JPEG image was taken and the data remains in the buffer). |
| AE-L | Displays the file management screen for deleting images, protecting images, transferring files, and saving the RAW data. |

Memo



- You can use **AF** to focus on the subject. (p.59)
- You can preview the image on the monitor and check the depth of field before shooting. (p.66)
- You can set the operation and display settings for Instant Review in [Instant Review] of the **C4** menu. (p.105)
- When you want to lock the exposure value (AE Lock) by pressing **SHUTTER** halfway, make settings in [Still Image] of [AF/AE Lock Settings] in the **C2** menu.

| | |
|--------------------------|--|
| Shutter/AF Button | Enable AF, Enable AF No Function, Enable AF Enable AF, Cancel AF |
| Shooting AE Lock | Shutter Halfway Press When in Focus Off |

Caution

- Some functions are not available in **AUTO** mode.

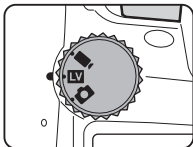

Shooting while Viewing the Live View Image

- 1** Set the /LV/ dial to **LV** in Step 3 of “Shooting with the Viewfinder” (p.43). The Live View image is displayed on the monitor.



- 2** View the Live View image.

Available operations

| | |
|---|---|
|  | Magnifies the image and returns to 1× image display. |
|  | Changes the magnification (up to 16×). |
|  | Change the area to display. Push the lever in to return the display area to the center of the image. |

- 3** Position the subject inside the AF frame on the monitor and press **SHUTTER** halfway.

The AF frame turns green and you will hear a beep when the subject comes into focus.



Subsequent steps are the same as shooting with the viewfinder.



AF frame

Disabling Operation Controls

Operation of buttons and dials can be temporarily disabled to prevent misoperation during shooting.

Turning  while pressing  disables the operation of buttons and dials. Turning  again enables the operation of them.

 is displayed on the status screen as well as in the viewfinder and Live View while the operation of buttons and dials is disabled.

The group of buttons and dials to be disabled can be selected in [Operation Control Lock] of [Fx Button] in the **C2** menu. (p.99)



How to Use a Retractable Lens

If the camera is turned on when a retractable lens, such as HD PENTAX-DA 18-50mm F4-5.6 DC WR RE, is attached and is not extended, an error message is displayed on the monitor. Turn the zoom ring in the direction of **②**

while pressing the button on the ring **①** to extend the lens. When retracting the lens, turn the zoom ring in the opposite direction to **②** while pressing the button on the ring and align the white dot to the position **③**.

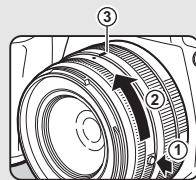

Reviewing Images

You can review the captured image on the monitor.

1 Press .

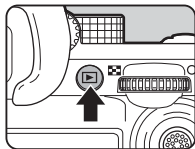









The camera enters the playback mode and the most recently captured image is displayed (single image display).





2 Review the captured image.

Available operations

| | |
|---|--|
|  /  / Flick | Displays the previous or next image. |
|  | Deletes the image. |
|  to the right / Pinch out / Double-tap | Magnifies the image (up to 16×). Use  to change the area to display. Push the lever in to return the display area to the center of the image. |
|  | Magnifies the image with the magnification set in [Quick Zoom] of [Zoom Review] in the C4 menu. (p.105) In magnified view: Returns to the entire image display. |

| | |
|---|---|
|  to the left / Pinch in | Switches to the thumbnail display (p.82). |
|  | Switches between the SD1 card and the SD2 card. |
| RAW | Saves the RAW data (only when a JPEG image was taken and the data remains in the buffer). |
| INFO | Changes the type of information displayed (p.14). |
| AE-L / Tap and hold | Displays the playback function selection screen (p.82). |

Memo

- When  is turned to the right to magnify the image, the magnification is displayed at the bottom right of the screen. "100%" appears when the image is displayed at the actual pixel size (1× image display). You can set the display magnification and trigger operation when magnifying images in [Quick Zoom] of [Zoom Review] in the **C4** menu. (p.105)
- When **RAW** is displayed on the monitor, the JPEG image that was just taken can also be saved in RAW format (Save RAW Data).
- You can change the information to display in the single image display in [Playback Info Display] of [Monitor Display] in the **C4** menu. (p.104)
- While the power is on, the last played image is stored. If you want to store the last played image even when the camera is turned off, set [Image for Playback] to  (On) in [Memory] of the **C5** menu. (p.107)

Configuring the Capture Settings

Memory Card Recording Settings

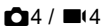

You can set the recording method for when two memory cards are inserted in [Memory Card Options] of the menu.

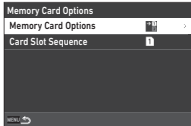

| | |
|--------------------------|--|
| Sequential Use | When the memory card in one slot becomes full, saves data to the card in the other slot. The slot to use can be switched with [Card Slot Sequence]. |
| Save to Both | Saves the same data to the memory cards in both the SD1 and the SD2 slots. |
| Separate RAW/JPEG | Saves the RAW data to the memory card in the SD1 slot, and the JPEG data to the card in the SD2 slot. |

In mode, select [SD1] or [SD2] as the slot to use for saving movies.

Still Image Capture Settings



You can set the file format for still images in the menu.

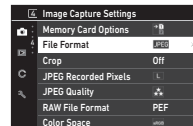

| | |
|-----------------------------|---------------------------|
| File Format | JPEG, RAW, RAW+JPEG |
| Crop | 1.3x, 1.7x, Off |
| JPEG Recorded Pixels | [L], [M], [S], [XS] |
| JPEG Quality | Super Fine, Fine, Economy |
| RAW File Format | PEF, DNG |
| Color Space | sRGB, AdobeRGB |

⚠ Caution

- When [Memory Card Options] is set to [Separate RAW/JPEG] in the menu, [File Format] is fixed to [RAW+JPEG].
- The selectable size for [JPEG Recorded Pixels] is limited depending on the [Crop] setting.

| [Crop] Setting | Selectable Size for [JPEG Recorded Pixels] |
|----------------|--|
| 1.3x | [M], [S], [XS] |
| 1.7x | [S], [XS] |

📝 Memo

- When [File Format] is set to [RAW+JPEG], a JPEG image and a RAW image with the same file number are saved at the same time.
- You can change the setting so that you can take images in another file format when **RAW** is pressed (One Push File Format). (p.99)
- [PEF] of [RAW File Format] is a PENTAX original RAW file format.
- When [Crop] is set to [1.3x], the cropping frame is displayed in the viewfinder. (p.16) Perform shooting so that the subject is positioned in the frame.

Movie Capture Settings ■(4)

You can set the file format for movies in [Movie Capture Settings] of the ■(4) menu.

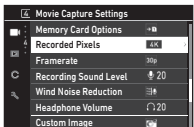

| | |
|------------------------------|------------------------|
| Recorded Pixels | [4K], [FHD] |
| Framerate | 60p, 30p, 24p |
| Recording Sound Level | Auto, Manual (0 to 40) |
| Wind Noise Reduction | On, Off |
| Headphone Volume | 0 to 40 |

⚠ Caution

- When [Recorded Pixels] is set to [4K], [60p] cannot be selected for [Framerate].

📌 Memo

- Setting [Wind Noise Reduction] to [On] cuts off the low-pitch sound. It is recommended to set [Wind Noise Reduction] to [Off] when it is not necessary.

Taking Still Images

Select the capture mode that suits the subject and shooting conditions.

The following capture modes are available on this camera.

| Capture Mode | Function | Page |
|--|--|------|
| AUTO (Scene Analyze Auto mode) | Automatically sets the optimal shooting settings. | p.43 |
| P, Sv, Tv, Av, TAv, M, B, X (Exposure modes) | Allows you to change the shutter speed, aperture value, and ISO sensitivity. | p.49 |
| U1 to U5 (User modes) | Allows you to save frequently used exposure modes and capture settings together. | p.96 |

Exposure Modes

✓: Available # : Restricted X : Not available

| Mode | Changing Shutter Speed | Changing Aperture Value | Changing ISO Sensitivity | EV Compensation |
|--|------------------------|-------------------------|--------------------------|-----------------|
| P Program AE | # *1 | # *1 | ✓ | ✓ |
| Sv Sensitivity Priority AE | # *1 | # *1 | ✓ *2 | ✓ |
| Tv Shutter Priority AE | ✓ | # *1 | ✓ | ✓ |
| Av Aperture Priority AE | # *1 | ✓ | ✓ | ✓ |
| TAv Shutter & Aperture Priority AE | ✓ | ✓ | # *1 | ✓ |
| M Manual Exposure | ✓ | ✓ | ✓ *2 | ✓ |
| B Bulb Exposure | X *3 | ✓ | ✓ *2 | X |
| X Flash X-sync Speed | X *4 | ✓ | ✓ *2 | ✓ |

*1 You can set the value to be changed in [E-Dial Programming] of the C2 menu. (p.100)

*2 ISO Auto is not available.

*3 You can change the shutter speed in the range of 1 second to 20 minutes for the timed exposure. (p.52)

*4 You can change the flash sync speed in [X Mode Sync Speed] of the C5 menu.

1 Set the mode dial to the desired exposure mode.

☺, ☹, or ○ appears next to the value on the status screen and Live View in the following situations.

- When a fixed value is set and it can be changed with ☺, ☹, or ○
- When the camera is in the mode to change values after operations such as pressing a function button

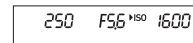

▶ appears next to the value that can be changed on the outside-field-of-view information in the viewfinder and on the LCD panel.

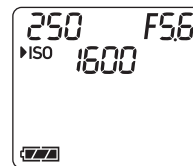

3

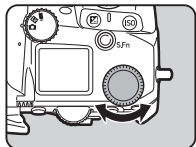
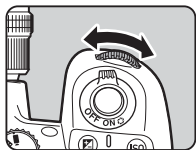
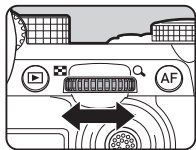

Shooting

2 Turn or .



When [E-Dial], [ISO Sensitivity], or [EV Compensation] is set for the Smart Function, turn .

Memo

- The exposure value can be specified in increments of 1/3 EV steps. In [EV Steps] of the **C5** menu, you can change the adjustment steps to 1/2 EV steps.
- In **M** or **X** mode, the difference from the correct exposure is displayed on the EV bar scale while the exposure is adjusted.
- For each exposure mode, you can set the camera operation for when  or  is turned or  is pressed. Make settings in [E-Dial Programming] of the **C2** menu. (p.100)
- To compensate the exposure automatically by pressing **SHUTTER** halfway when the correct exposure cannot be achieved, set [Auto EV Compensation] to [On] in the **C2** menu. When you release **SHUTTER**, the exposure returns to the original value.
- While shooting with Live View in **M**, **X**, or **B** (with the timed exposure set) mode, the brightness of Live View changes according to the exposure setting. To not adjust the brightness according to the exposure setting, set [Exp. Simulation LV] to [Off] in the **C2** menu.

Caution

- The correct exposure may not be obtained with the selected shutter speed and aperture value when the ISO sensitivity is fixed at a certain sensitivity. (If the ISO sensitivity is set to ISO Auto, the correct exposure may be obtained.)
- In **B** mode, [Drive Mode] cannot be set to [Continuous Shooting], [Bracketing], [Interval Shooting], or [Interval Composite] in the **C3** menu. (When the timed exposure is set, you can select [Interval Shooting] and [Interval Composite].)

Autofocusing Using the Touch Panel

While shooting with Live View, you can change the AF point using the touch panel. To perform autofocus and shooting using the touch panel, make settings in [LV Shooting Touch AF] of the **C3** menu.

| | |
|-----------------------------|--|
| AF Point | Sets the AF point to the touched point. (Default setting) |
| AF Point+Focus | Sets the AF point to the touched point and performs autofocus. |
| AF Point+Focus+Shoot | Sets the AF point to the touched point, and performs autofocus and shooting. |
| Off | Does not use the touch panel for shooting. |

Reducing Noise when Shooting with a Slow Shutter Speed



When shooting with a slow shutter speed, you can reduce image noise in [Slow Shutter Speed NR] of [Noise Reduction] in the 5 menu.

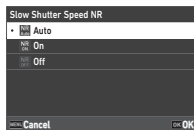

| | |
|-------------|--|
| Auto | Applies noise reduction according to the ISO sensitivity, shutter speed, and internal temperature of the camera. |
| On | Applies noise reduction when the shutter speed is slower than 1 second. |
| Off | Does not apply noise reduction at any shutter speed. |

Setting the Exposure Control Method



In [Program Line] of the 2 menu, you can specify how exposure is controlled in **P**, **Sv**, **TAv**, and **M** modes.

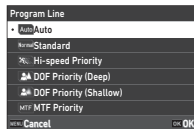

| | |
|-------------------------------|--|
| Auto | Determines the appropriate settings. |
| Standard | Sets to the basic program automatic exposure (all-around mode). |
| Hi-speed Priority | Prioritizes high shutter speeds. |
| DOF Priority (Deep) | Closes the aperture for a deep depth of field. |
| DOF Priority (Shallow) | Opens the aperture for a shallow depth of field. |
| MTF Priority | Sets the sharpest aperture of the attached lens when a D FA, DA, DA L, FA, or FA J lens is used. |

Hyper Program

You can shift the shutter speed and aperture value while keeping the correct exposure by changing the shutter speed or aperture value in **P** mode. This feature is called "hyper program". When the camera enters the hyper program mode, the exposure mode is temporarily displayed as **Tv** or **Av** mode. Either the shutter speed or the aperture value can be changed in the hyper program mode. Press to return to the normal **P** mode.

Hyper Manual

In **M** mode where the ISO sensitivity, shutter speed, and aperture value can be set freely, the automatic exposure control is temporarily performed only while is pressed. The exposure mode to change when is pressed can be set in [E-Dial Programming] of the **C2** menu. (p.100)

Advanced Mode

When [HYPER P/Sv Options] of [E-Dial Programming] is set to [Advanced] in the **C2** menu, you can use the “advanced mode” in **P** or **Sv** mode. (p.101) To use the hyper mode in other exposure modes, assign the hyper mode function to dials in [E-Dial Programming] of the **C2** menu (p.100). If you change the ISO sensitivity, shutter speed, and aperture value, the camera enters the hyper mode for each item in the order in which the value is changed. When all the ISO sensitivity, shutter speed, and aperture value are changed, the camera enters the hyper **M** mode. Press **Q** to return to the exposure mode set with the mode dial.

| Exposure Mode | ISO Sensitivity | Operation 1 | Hyper Mode | Operation 2 | Hyper Mode | Operation 3 | Hyper Mode |
|---------------|-----------------|-----------------|------------|-----------------|------------|-----------------|------------|
| P | AUTO | Aperture value | Av | Shutter speed | TAv | ISO sensitivity | M |
| | | Shutter speed | Tv | Aperture value | TAv | ISO sensitivity | M |
| | Fixed value | Aperture value | Av | Shutter speed | M | | |
| | | Shutter speed | Tv | Aperture value | M | | |
| Sv | Fixed value | Aperture value | Av | Shutter speed | M | | |
| | | Shutter speed | Tv | Aperture value | M | | |
| Tv | AUTO | Aperture value | TAv | ISO sensitivity | M | | |
| | Fixed value | Aperture value | M | | | | |
| Av | AUTO | Shutter speed | TAv | ISO sensitivity | M | | |
| | Fixed value | Shutter speed | M | | | | |
| TAv | AUTO | ISO sensitivity | M | | | | |

Example) In **P** mode with ISO Auto

- **P** → (Change the aperture value) → Hyper **Av** mode → (Change the shutter speed) → Hyper **TAv** mode → (Change the ISO sensitivity) → Hyper **M** mode

Bulb Exposure

- 1 Set the mode dial to **B**.
- 2 Use  to set the aperture value.



- 3 To enable the timed exposure, press **Q**, and then turn  to set the exposure time.

You can set the exposure time within the range from 1" to 20'00".

- 4 Press **SHUTTER**.

While **SHUTTER** is pressed, the exposure continues.

If the timed exposure is enabled in Step 3, the exposure ends when the set exposure time elapses after **SHUTTER** is fully pressed.

Memo

- You can start and end the exposure also by pressing **SHUTTER**. Make settings in [Bulb (B) Mode Options] of the **C5** menu.

| | |
|-------------|---|
| Bulb | While SHUTTER is pressed, the exposure continues. (Default setting) |
| Time | The exposure starts when SHUTTER is pressed and ends when SHUTTER is pressed again. |

- During the bulb exposure, [Shake Reduction] is fixed to [Off] in the **Q6** menu.
- When performing the bulb exposure, use a tripod and mount the camera on it securely. The use of the optional cable release is recommended.
- You can shoot celestial bodies using the bulb exposure. (p.117)

⚠ Caution

- The following functions cannot be set in **B** mode.
 - [Continuous Shooting] and [Bracketing] in [Drive Mode] of the 3 menu
 - [Electronic Shutter] in [Shutter Mode Selection] of the 3 menu
- When the timed exposure is not set, [Drive Mode] cannot be set to [Interval Shooting] or [Interval Composite] in the 3 menu.

EV Compensation

The compensation value can be set between -5 and +5 EV (-2 and +2 EV in mode).

- 1 Press , and then turn .

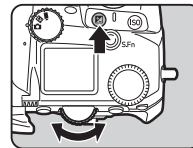

Available operations

- | | |
|--|---|
| | Starts/ends adjusting the compensation value. |
| | Resets the compensation value to the default setting. |

📌 Memo

- You can make settings so that pressing resets the compensation value when the exposure compensation function is assigned to , , or . Make settings in [One Push Exposure Reset] of the **C2** menu.

Using the Electronic Shutter



For shooting with the “mechanical shutter”, the shutter curtain operates to capture images. When the shutter operates, it makes an operating sound and vibration. You can use the “electronic shutter” to reduce the operating sound and vibration or perform shooting at a high shutter speed.

When using only the electronic shutter, set [Shutter Mode Selection] to [Electronic Shutter] in the menu.

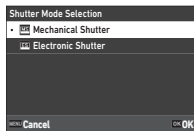

Caution

- [Electronic Shutter] cannot be set in the following situation.
 - In **B** mode
- When [Electronic Shutter] is set, the following function cannot be used.
 - Flash
- If you perform shooting at a high shutter speed with [Electronic Shutter] set, moving subjects may appear distorted.

Memo

- When [Electronic Shutter] is set, shooting while looking at the Live View image (p.45) allows for quieter shooting.

Recording Movies

- 1 Set the /LV/ dial to .

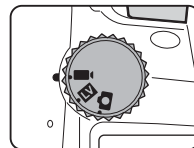

Live View appears.

Sound



Recording time

- 2 Use the mode dial to select an exposure mode. **P**, **Tv**, **Av**, **TAv**, or **M** mode can be selected.
- 3 Use or to set the exposure.
- 4 Focus on the subject.
When the focus method is set to **AF**, press **SHUTTER** halfway.
- 5 Press **SHUTTER** fully.
Movie recording starts.
- 6 Press **SHUTTER** fully again.
Movie recording stops.

⚠ Caution

- When recording a movie with sound, camera operation sounds are also recorded.
- When recording a movie with an image processing function such as [Digital Filter] of the **■15** menu applied, the movie file may be saved with some frames omitted.
- If the internal temperature of the camera becomes high during recording, recording may be terminated.
- When a retractable lens is attached, recording stops if the lens is retracted during recording and an error message is displayed.

📌 Memo

- When the mode dial is set to other than the modes described in Step 2, the camera operates in **P** mode.
- You can set the autofocus operation during movie shooting in [Movie Mode AF] of [AF with Live View] in the **■1** menu.
- When a compatible lens is attached to the camera, [AF Mode] can be set to [Continuous AF] in [AF with Live View] of the **■1** menu. When [Continuous AF] is set, autofocus is always performed even while recording a movie.
- To disable the autofocus operation with **SHUTTER** pressed halfway in **■1** mode, set [Movie] to [Off] in [AF/AE Lock Settings] of the **C2** menu.
- You can record a movie continuously up to 4 GB or 25 minutes. When the memory card is full, recording stops.

Movie Recording Using the Touch Panel

When recording a movie, you can start and stop recording and change the following settings using the touch panel.

- ISO sensitivity, shutter speed, aperture value, and exposure compensation value
- AF point
- Screen display on/off

To perform autofocus while recording a movie, make settings in [Movie Touch AF] of the **C3** menu.

| | |
|----------------------------------|--|
| AF Point | Sets the AF point to the touched point. (Default setting) |
| AF Point+ Continuous AF | Sets the AF point to the touched point and continues autofocus when a compatible lens is attached to the camera. |
| AF Point+Sgl. AF at Start | Sets the AF point to the touched point and performs autofocus once. |
| Off | Does not use the touch panel for recording movies. |

Using a Microphone or Headphones

You can reduce the possibility of recording camera operation sounds by connecting a commercially available stereo microphone to the microphone terminal on the camera.

The following specifications are recommended for external microphones. (A monaural microphone cannot be used with this camera.)

| | |
|------------------|--|
| Plug | Stereo mini plug (3.5 mm dia.) |
| Format | Stereo electret condenser |
| Power | Plug-in Power Method (operating voltage of 2.0 V or lower) |
| Impedance | 2.2 kΩ |

You can record and play back movies while listening to the sound by connecting commercially available headphones to the headphone terminal.

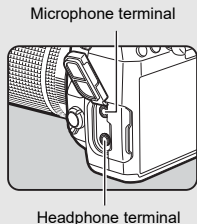

Playing Back Movies

1 Display the movie to play back in the single image display of the playback mode.

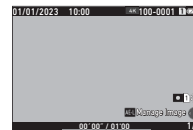

Available operations

| | |
|----------------|---|
| ▲ / Tap | Plays back/Pauses a movie. |
| ◀▶ | Fast-reverses/Fast-forwards playback. Reverses/Forwards a frame (when paused). |
| ▼ / Double-tap | Stops playback. |
| | Adjusts the sound volume (41 levels). |
| AE-L | Saves the displayed frame as a JPEG file (when paused). |
| INFO | Switches between [Standard Info. Display] and [No Information Display]. |

⚠ Caution

- Do not connect a microphone or other device outside the recommended specifications to the microphone terminal or headphone terminal. Also, do not use an external microphone with a 3-m or longer cable. Doing so may cause the camera to malfunction.
- If an external microphone is used when recording a movie with the wireless LAN function enabled, radio noise may be recorded depending on the compatibility with the microphone.

⚠ Caution

- Only movies recorded with this camera can be played back.

🌀 Memo

- The sound volume at the start of movie playback can be set in [Playback Sound Volume] of the **▶ 1** menu. (p.82)
- You can divide a movie file into multiple segments or delete selected frames in the **▶ 6** menu. (p.92)



Setting the Exposure

ISO Sensitivity

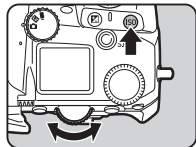



- 1 Press **ISO**, and then turn .



Available operations

- | | |
|---|---|
|  | Starts/ends changing the ISO sensitivity. |
|  | Resets the ISO sensitivity to ISO Auto. |

Memo

- In  mode, the ISO sensitivity can be set from ISO 200 to ISO 25600.
- The adjustment steps for the ISO sensitivity is 1 EV step. To adjust the ISO sensitivity in accordance with the EV step setting for the exposure, make settings in [ISO Sensitivity Steps] of the **C5** menu.
- You can make settings so that pressing **ISO** resets the ISO sensitivity to ISO Auto without displaying the setting screen when the ISO sensitivity setting function is assigned to , , or . Make settings in [One Push ISO Auto] of the **C2** menu.

Setting the Range of ISO Auto



You can set the range in which the ISO sensitivity is automatically adjusted when the ISO sensitivity is set to ISO Auto. Make settings in [ISO Sensitivity Setting] of the  menu.

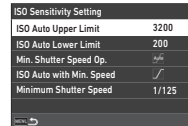

| | |
|--------------------------|-------|
| ISO Sensitivity Setting | |
| ISO Auto Upper Limit | 3200 |
| ISO Auto Lower Limit | 200 |
| Min. Shutter Speed Op. | ☑ |
| ISO Auto with Min. Speed | ☑ |
| Minimum Shutter Speed | 1/125 |

| | |
|---------------------------------|---|
| ISO Auto Upper Limit | Sets the ISO sensitivity upper limit for ISO Auto. |
| ISO Auto Lower Limit | Sets the ISO sensitivity lower limit for ISO Auto. |
| Min. Shutter Speed Op. | Sets whether to automatically determine the lower limit according to the focal length information of the lens or to manually set the limit. |
| ISO Auto with Min. Speed | Sets the manner in which the ISO sensitivity is increased when [Min. Shutter Speed Op.] is set to [Auto]. |
| Minimum Shutter Speed | Sets the shutter speed in units of 1 EV when [Min. Shutter Speed Op.] is set to [Shutter Speed Control]. |

Reducing Noise when Shooting with a High ISO Sensitivity

You can use the noise reduction feature when shooting with a high ISO sensitivity.

- 1 Select **[Noise Reduction]** in the  menu and press **▶**.
The [Noise Reduction] screen appears.
- 2 Select **[High-ISO Noise Reduction]** and press **▶**.
- 3 Select the noise reduction level and press **OK**.

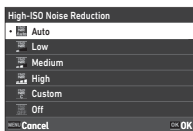

| | |
|--------------------------|--|
| Auto | Applies noise reduction at optimally calculated levels throughout ISO sensitivity range. |
| Low, Medium, High | Applies noise reduction at constant chosen level throughout ISO sensitivity range. |
| Custom | Applies noise reduction at user-defined levels for each ISO sensitivity setting. |
| Off | Does not apply noise reduction at any ISO sensitivity setting. |



Proceed to Step 7 when other than [Custom] is selected.

- 4 Select **[Custom Options]** and press **▶**.

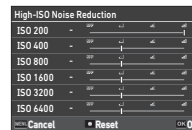
- 5 Select the noise reduction level for each ISO sensitivity setting.



Available operations

-  Selects the ISO sensitivity.
 -  Selects the noise reduction level.
 -  Resets the noise reduction level to the default setting.
- 6 Press **OK**.
The screen of Step 3 reappears.
 - 7 Press **MENU** twice.

You can choose the part of the sensor to use for measuring brightness and determining the exposure.

1 Press , and then turn



Alternatively, select [AE Metering] in the or menu.

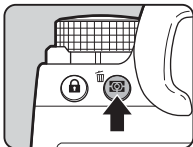

| | |
|---------------------------|--|
| Multi-segment | Meters the brightness in multiple different zones of the sensor. In backlit conditions, this mode automatically adjusts the exposure. |
| Center-weighted | Meters the brightness with an emphasis on the center of the sensor. The sensitivity increases at the center and no automatic adjustment is performed even in backlit conditions. |
| Spot | Meters the brightness only within a limited area at the center of the sensor. |
| Highlight-weighted | Meters the exposure in multiple areas of the frame with emphasis on the bright areas. |

Memo

- To adjust the exposure for detected faces when [Multi-segment] is selected, set [Face Priority AE] to [On] in the menu.
- To adjust the exposure according to the brightness at the AF point when [Multi-segment] or [Spot] is selected, set [Link AE and AF Point] to [On] in the menu.

Setting the Focus Method

Set the focus method switch to **AF** or **MF**.

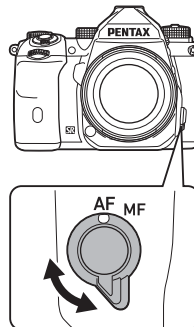

The autofocus method for shooting with the viewfinder differs from that for shooting with Live View.

| | |
|-------------------------------------|--|
| Shooting with the viewfinder | Phase-matching detection autofocus: [Single AF] or [Continuous AF] can be selected. Faster autofocus performance than the contrast detection autofocus is possible. |
| Shooting with Live View | Contrast detection autofocus |

Focusing on the Subject Using **AF**

You can use **AF** to perform autofocus.

The **SHUTTER / AF** operation can be set in [AF/AE Lock Settings] of the **C2** menu. (p.100)

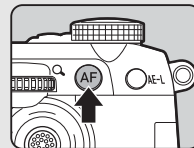

Setting the Autofocus when Shooting with the Viewfinder



You can set the autofocus operation when shooting with the viewfinder in [AF with Viewfinder] of the 1 menu.

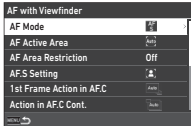

Memo

- The [AF Mode] and [AF Active Area] setting can be changed by pressing and then turning or . (p.60)

AF Mode

1 Press , and then turn

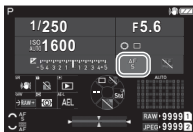
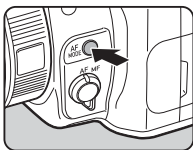

| | |
|----------------------|---|
| Single AF | When SHUTTER is pressed halfway and the subject comes into focus, the focus is locked at that position. The AF assist light turns on as necessary. |
| Continuous AF | The subject is kept in focus by continuous adjustment while SHUTTER is pressed halfway. The shutter can be released even if the subject is not in focus. |

AF Active Area (AF Point)





You can select the AF points.

The AF points can be selected from 41 points out of 101 points.

1 Press , and then turn



| | |
|-----------------------------|--|
| Auto Area | Automatically selects the optimum focusing points out of all AF points. |
| Zone Select | Automatically selects the optimum focusing points out of the selected 21 AF points. |
| Select | Sets the AF points to five user-selected points. |
| Expanded Area AF (S) | Sets the AF points to five user-selected points. When the subject happens to move out of the selected AF points after being focused, 16 peripheral points are used as back-up points for autofocus. This setting is available only with [Continuous AF]. |
| Expanded Area AF (M) | Sets the AF points to five user-selected points. When the subject happens to move out of the selected AF points after being focused, 60 peripheral points are used as back-up points for autofocus. This setting is available only with [Continuous AF]. |

| | |
|---|--|
|  Expanded Area AF (L) | Sets the AF points to five user-selected points. When the subject happens to move out of the selected AF points after being focused, 96 peripheral points are used as back-up points for autofocus. This setting is available only with [Continuous AF]. |
|  Select (S) | Sets the AF point to a user-selected point. |
|  Select (XS) | Performs autofocus in a narrower range than [Select (S)]. |
|  Spot | Sets the AF point to the center point. |

Proceed to Step 2 when other than [Auto Area] or [Spot] is selected.

2 Use to select the desired AF points.

Push the lever in to reset the AF points.

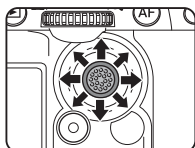

The selected AF points are displayed on the status screen.



Memo

- The selected AF points can be checked also in the viewfinder. (p.16)

Caution

- The selectable AF points differ depending on the lens attached. (p.113)

AF Area Restriction

You can limit the range of AF points.

When [AF Area Restriction] is set to [On], only the inner AF frame is used.

AF.S Setting

You can select the camera operation priority for when the **SHUTTER** is pressed fully while the autofocus mode is set to [Single AF] from [Focus-priority] and [Release-priority].

1st Frame Action in AF.C

You can select the camera operation priority for the first frame when the **SHUTTER** is pressed fully while the autofocus mode is set to [Continuous AF] from [Auto], [Focus-priority], and [Release-priority].

Action in AF.C Cont.

You can select the camera operation priority for continuous shooting when the autofocus mode is set to [Continuous AF] from [Auto], [Focus-priority], and [FPS-priority].

Hold AF Status

You can set whether to immediately reactivate autofocus or to maintain the focus for a certain amount of time before reactivating autofocus when the subject happens to move out of the selected focusing points while tracking the subject with [Continuous AF]. The setting can be selected from [Off], [Low], [Medium], and [High].

AF Point for H/V Comp.

You can set whether to memorize the AF point for each of the vertical and horizontal compositions. In addition, the position to which the AF point returns when the AF point selector lever is pushed in can be set.

| | |
|-------------------|---|
| Common | Maintains the same AF point even when the composition is changed. |
| Individual | Memorizes the AF point for each of the vertical and horizontal compositions. The AF point switches to the memorized position when the composition is changed. |

Action When AF Fails

You can select whether to adjust focus manually with the lens or to wait until the camera can perform autofocus when autofocus fails.

AF Point Tracking in AF.C

You can set the method for tracking AF points when the autofocus mode is set to [Continuous AF].

| | |
|--------|---|
| Type 1 | Tracks AF points using AF sensor and AE sensor information. |
| Type 2 | Tracks AF points using AF sensor information only. |

Subject Recognition

You can make settings so that the recognized subject is prioritized while autofocusing when [AF Active Area] is set to [Auto Area] or [Zone Select].

Catch-in Focus

You can perform Catch-in Focus shooting. The shutter is released automatically when the subject comes into focus. Use a manual focus lens or a lens with the **AF/MF** switch set to **MF**.

- 1 Attach a manual focus lens to the camera.**
- 2 Set the focus method to **AF**.**
- 3 Set [Catch-in Focus] to [On] in [AF with Viewfinder] of the 1 menu.**
- 4 Place the camera on a fixed support such as tripods.**
- 5 Adjust the focus to the position where the subject may pass and press **SHUTTER** fully.**
When the subject comes into focus at the specified position, the shutter is released automatically.

Setting the Autofocus when Shooting with Live View

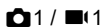

You can set the autofocus operation when shooting with Live View in [AF with Live View] of the 1 or 1 menu.

1 Menu

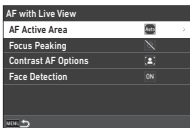

1 Menu

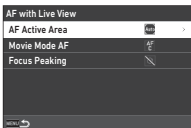

Memo

- The [AF Active Area] setting can be changed by pressing and then turning . (p.63)

AF Active Area

You can select the AF active areas.

- 1 Press , and then turn .

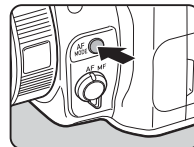

| | | |
|--|--------------------|---|
| | Auto Area | Automatically selects the optimum focusing area out of all AF active areas. |
| | Zone Select | Performs autofocus in the selected 3×3 areas. |
| | Tracking *1 | Tracks the subject in focus. |
| | Select (L) | Performs autofocus with more areas than those for [Select (M)]. |
| | Select (M) | Performs autofocus with the selected areas. |
| | Select (S) | Performs autofocus with fewer areas than those for [Select (M)]. |
| | Spot | Sets the AF active area to the center area. |

*1 Not available in 1 mode.

Proceed to Step 2 when other than [Auto Area] or [Spot] is selected.

- 2 Use **AF** to select the AF active areas.
Push the lever in to reset the AF active areas.

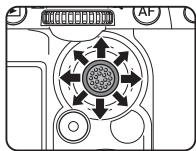

Movie Mode AF

You can set the autofocus operation in **Movie** mode. Select whether to lock focus or continue autofocus. When [Continuous AF] is selected, autofocus is performed automatically without pressing **SHUTTER** halfway. The continuous autofocus function is available only when a compatible lens is attached.

Focus Peaking

When [Highlight Edge] or [Extract Edge] is selected, the outline and contrast of the subject in focus are emphasized, and this makes it easier to check the focus. This function works in both **AF** and **MF** focus methods.

⚠ Caution

- While autofocusing and recording a movie, focus peaking is not displayed.
- While focus peaking is displayed, the histogram and highlight alert are not displayed.

Contrast AF Options

You can select the camera operation priority for when the **SHUTTER** is pressed fully from [Focus-priority] and [Release-priority].

Face Detection

You can make settings so that the camera detects the faces of up to ten people and performs autofocus for the detected faces.

| | |
|--------------------------|--|
| On | Detects faces when [AF Active Area] is set to other than [Tracking]. |
| Only in Auto Area | Detects faces only when [AF Active Area] is set to [Auto Area]. |
| Off | Follows the [Face Detection] setting without detecting faces. |

AF Assist Light

You can illuminate the assist light when autofocusing in dark locations.

Focus Limiter

When a compatible lens is attached to the camera, [Focus Limiter] can be set in the  1 menu. You can limit the focusing range for autofocus.

| | |
|------------------|---|
| Near Side | Limits the focusing range to the near side. |
| Far Side | Limits the focusing range to the far side. |
| Off | Does not limit the focusing range. |

Fine-tuning the Autofocus

C6

You can precisely fine-tune your lenses with the camera's autofocus system.

1 Select [AF Fine Adjustment] in the C6 menu and press .

The [AF Fine Adjustment] screen appears.

2 Press .

The adjustment method selection screen appears.



3 Select the adjustment method and press **OK**.

| | |
|-------------------|--|
| Common | Applies the same adjustment value to all lenses. |
| Individual | Saves an adjustment value for the lens being used. (Up to 20 values can be saved.) |
| Off | Does not fine-tune the autofocus. |

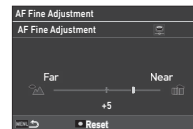
4 Press and adjust the value.



Available operations

-  Adjusts the focus to a closer position (toward the front).
-  Adjusts the focus to a farther position (toward the rear).
-  When [Individual] is selected: Resets the adjustment value to the default setting.

5 Press **MENU** twice.

The camera returns to the standby mode.

Checking the Depth of Field (Preview)

Turn the main switch to  to use the preview function.

There are two preview methods.

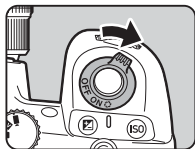

| | |
|------------------------|---|
| Optical Preview | Activates the Optical Preview function to check the depth of field with the viewfinder. |
| Digital Preview | Activates the Digital Preview function to check the composition, exposure, and focus on the monitor. You can magnify or save the preview image. |

Memo

- Press **MENU** during Digital Preview to end the preview.

Setting the Preview Method

C2

- 1 Select **[Preview Dial]** in the **C2** menu and press .

The [Preview Dial] screen appears.

- 2 Select **[Preview Method]** and press .

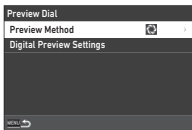

- 3 Select **[Optical Preview]** or **[Digital Preview]**, and press **OK**.

When [Digital Preview] is selected, the operations and information displayed during the preview can be set in [Digital Preview Settings].

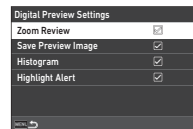

- 4 Press **MENU** two or three times.

The camera returns to the standby mode.

Caution

- The effects of some functions cannot be checked during Digital Preview or are not applied to the saved preview image.

Selecting the Drive Mode



You can use the [Drive] and [Timer/Remote Control] functions in combination.

1 Press ▲ in the standby mode.

Alternatively, select [Drive Mode] in the menu. The [Drive Mode] screen appears.

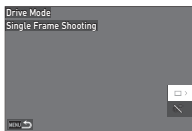

2 Press ►.

The [Drive] screen appears. Refer to p.74 for [Timer/Remote Control].

3 Use ▲▼ to select a drive mode.

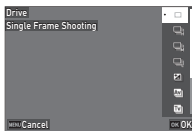

| | |
|--|--|
| Single Frame Shooting | Performs normal shooting. |
| Continuous Shooting (H) Continuous Shooting (M) Continuous Shooting (L) | Continuously takes images while SHUTTER is kept pressed. (p.68) |
| Bracketing | Takes consecutive images at different exposure levels. (p.68) |
| Depth of Field Bracketing | Continuously takes images with different depth-of-field settings (aperture values). (p.69) |

| | |
|--------------------------------|--|
| Motion Bracketing | Continuously takes images with different shutter speeds. (p.70) |
| Mirror Lock-up Shooting | Takes images with the mirror raised. The mirror is raised when SHUTTER is pressed fully, and an image is taken when SHUTTER is pressed fully again. (p.70) |
| Multi-exposure | Creates a composite image by taking multiple images and merging them into a single image. (p.71) |
| Interval Shooting | Takes images at the set interval and saves them. (p.72) |
| Interval Composite | Takes images at the set interval and merges them into a single image. (p.73) |

⚠ Caution

- There are restrictions on some drive modes when used in combination with some other functions. (p.111)



📌 Memo

- The [Drive] setting is saved even after the power is turned off. If [Drive] is set to (Off) in [Memory] of the **C5** menu, the setting returns to [Single Frame Shooting] when the power is turned off. (p.107)

Continuous Shooting

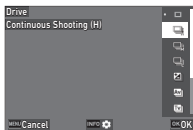
- 1 Select **[Continuous Shooting (H)]**, **[Continuous Shooting (M)]**, or **[Continuous Shooting (L)]** on the **[Drive]** screen.



| | |
|---|---|
|  | Performs continuous shooting at high speed. |
|  | Performs continuous shooting at medium speed. |
|  | Performs continuous shooting at low speed. |

- 2 Press **OK**.

The camera returns to the standby mode.

Memo



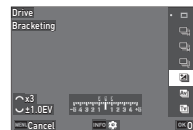

- When [AF Mode] is set to [Single AF] in [AF with Viewfinder] of the  1 menu, the autofocus position is locked at the focus position of the first image.
- When using the [Self-timer] function together, press **INFO** on the screen of Step 1 and set the number of shots in [No. of Cont. Timer Shots] (2 to 20).

Bracketing

- 1 Select **[Bracketing]** on the **[Drive]** screen.
- 2 Set the number of shots and bracket value.



Available operations

| | |
|---|---|
|  | Sets the number of shots. |
|  | Changes the bracket value. |
|  | Adjusts the exposure compensation value. |
|  | Resets the compensation value to the default setting. |

- 3 Press **INFO**.

- 4 Set the shooting conditions.

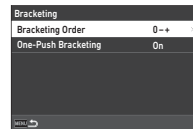

| | |
|----------------------------|---|
| Bracketing Order | Changes the shooting order of images. |
| One-Push Bracketing | Takes all images with one release of the shutter. |

- 5 Press **OK**.

The camera returns to the standby mode.

- 6 Shoot.

After images are taken, the camera returns to the standby mode.

Memo

- The bracket value can be set in increments of [1/3 EV Steps] or [1/2 EV Steps] according to the setting of [EV Steps] in the **C5** menu.
- The number of shots and bracket value can also be changed on the [Drive Mode] screen.

Depth of Field Bracketing

You can take three images continuously by changing the aperture value step by step without changing the exposure. This drive mode can be selected only in **Av** or **TAv** mode.

- 1 Select [Depth of Field Bracketing] on the [Drive] screen.
- 2 Set the bracket value.

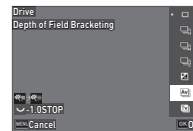

Available operations



Changes the bracket value.



Resets the bracket value to the default setting.

| | |
|------------------------------|---|
| Larger bracket value | Takes an image with a deep depth of field based on the current aperture value. |
| Smaller bracket value | Takes an image with a shallow depth of field based on the current aperture value. |

- 3 Press **OK**.

The camera returns to the standby mode.

- 4 Shoot.

Three images are taken with one release of the shutter. The camera returns to the standby mode.

Memo

- The bracket value can be set in increments of [1/3 EV Steps] or [1/2 EV Steps] according to the setting of [EV Steps] in the **C5** menu.

Caution

- [Depth of Field Bracketing] cannot be selected when a lens with an **A** position is used with the aperture ring set to a position other than **A**.

Motion Bracketing

You can take three images continuously by changing the shutter speed step by step without changing the exposure. This drive mode can be selected only in **Tv** or **TAv** mode.

1 Select **[Motion Bracketing]** on the **[Drive]** screen.

2 Set the bracket value.



Available operations



Changes the bracket value.



Resets the bracket value to the default setting.

| | |
|------------------------------|--|
| Larger bracket value | Takes an image in which the subject appears to be stationary based on the current shutter speed. |
| Smaller bracket value | Takes an image in which the subject appears to be moving based on the current shutter speed. |

3 Press **OK**.

The camera returns to the standby mode.

4 Shoot.

Three images are taken with one release of the shutter. The camera returns to the standby mode.

Memo

- The bracket value can be set in increments of [1/3 EV Steps] or [1/2 EV Steps] according to the setting of [EV Steps] in the **C5** menu.

Mirror Lock-up Shooting

1 Select **[Mirror Lock-up Shooting]** on the **[Drive]** screen.

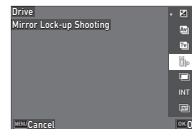

2 Press **OK**.

The camera returns to the standby mode.

3 Press **SHUTTER** halfway, and then fully.

The mirror pops up and the AE Lock function is activated.

4 Press **SHUTTER** fully again.

The mirror returns to its original position after the image is taken.

Memo

- A beep sound is made during mirror lock-up shooting. You can also make settings so that a beep sound is not made. (p.106)
- During mirror lock-up shooting, [Shake Reduction] is fixed to [Off] in the **6** menu.
- The outside-field-of-view information is not displayed in the viewfinder during mirror lock-up shooting.
- The mirror automatically returns to its original position if 1 minute elapses after the mirror pops up.

Multi-exposure

- 1 Select **[Multi-exposure]** on the **[Drive]** screen and press **INFO**.

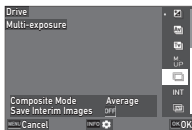

- 2 Set the shooting conditions.

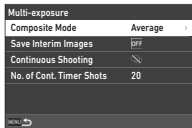

| | |
|---------------------------------|---|
| Composite Mode | [Average]: Creates a composite image with the average exposure. [Additive]: Creates a composite image with the cumulatively added exposure. [Bright]: Compares the captured image with the previous image pixel by pixel, and creates a composite image by replacing only the brightest pixel between the images. |
| Save Interim Images | Sets whether to save images in the middle of processing. |
| Continuous Shooting | Sets whether to perform continuous shooting. |
| No. of Cont. Timer Shots | Sets the number of images taken continuously after the countdown for shooting with [Self-timer]. The number of images can be selected from 2 to 20. |

- 3 Press **MENU**.
The screen of Step 1 reappears.
- 4 Press **OK**.
The camera returns to the standby mode.

- 5 Press **SHUTTER**.
The Instant Review image is displayed.

- 6 To take the next image, select **[Next shot]**, and then press **OK**.
Select **[Retake shot]** to retake the image.
Select **[Complete]** to end shooting.

⚠ Caution

- [Continuous Shooting] is not available in **B** mode.

Interval Shooting

1 Select **[Interval Shooting]** on the **[Drive]** screen and press **INFO**.

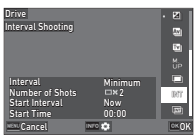

2 Set the shooting conditions.

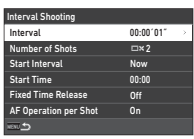

| | |
|------------------------------|--|
| Interval | Sets the shooting interval. The interval can be selected from [Minimum] and 1 second to 24 hours. |
| Number of Shots | Sets the number of images to take. The number can be selected from [∞] and 2 to 9999. |
| Start Interval | Sets the timing to take the first image. |
| Start Time | Sets the shooting start time for when [Start Interval] is set to [Set Time]. |
| Fixed Time Release | Sets whether to take images at the interval set in [Interval] regardless of the shutter speed. |
| AF Operation per Shot | Sets whether to lock the focus position used when the first image is taken or perform autofocus each time an image is taken. |

3 Press **MENU**.
The screen of Step 1 reappears.

4 Press **OK**.
The camera returns to the standby mode.

5 Press **SHUTTER**.
When [Start Interval] is set to [Now], the first image is taken. When [Start Interval] is set to [Set Time], shooting starts at the set time.
Press **OK** to cancel shooting.
After the specified number of images are taken, the camera returns to the standby mode.

Memo

- For each interval shooting, a new folder is created and the images are saved there.
- The second and later exposures start at the interval set in [Interval]. When the shutter speed is longer than the interval set in [Interval], the shooting result varies depending on the [Fixed Time Release] setting.

| Fixed Time Release | When the Shutter Speed Is Longer than the Interval Set in [Interval] |
|--------------------|---|
| On | Some shutter releases are skipped. Example) When [Interval] is set to 2 seconds, and the shutter speed is set to 3 seconds: The first exposure has not yet finished at the time the second exposure is supposed to be started (2 seconds after shooting has started), and so the second image is not taken. (Shooting ends before the images specified in [Number of Shots] are taken.) |
| Off | No shutter releases are skipped. Example) When [Interval] is set to 2 seconds, and the shutter speed is set to 3 seconds: The second exposure does not start even 2 seconds after shooting has started, and starts after the first exposure finishes. (Shooting ends after the images specified in [Number of Shots] are taken.) |

- When [Fixed Time Release] is set to [On], [Minimum] is not available for [Interval]. If [Interval] is set to [Minimum], the setting changes to [1sec.].
- The time set by [Minimum] in [Interval] varies depending on the combination with the **Q** menu functions.

Interval Composite

- 1 Select **[Interval Composite]** on the **[Drive]** screen and press **[INFO]**.



- 2 Set the shooting conditions.

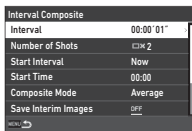

| | |
|------------------------------|--|
| Interval | Sets the shooting interval. The interval can be selected from [Minimum] and 1 second to 24 hours. |
| Number of Shots | Sets the number of images to take. The number can be selected from [∞] and 2 to 9999. |
| Start Interval | Sets the timing to take the first image. |
| Start Time | Sets the shooting start time for when [Start Interval] is set to [Set Time]. |
| Composite Mode | Sets the composite mode. The mode can be selected from [Average], [Additive], and [Bright]. |
| Save Interim Images | Sets whether to save images in the middle of processing. |
| Fixed Time Release | Sets whether to take images at the interval set in [Interval] regardless of the shutter speed. |
| AF Operation per Shot | Sets whether to lock the focus position used when the first image is taken or perform autofocus each time an image is taken. |

- 3 Press **[MENU]**.

The screen of Step 1 reappears.

- 4 Press **[OK]**.

The camera returns to the standby mode.

- 5 Press **[SHUTTER]**.

When [Start Interval] is set to [Now], the first image is taken. When [Start Interval] is set to [Set Time], shooting starts at the set time.

Press **[OK]** to cancel shooting.

After the specified number of images are taken, the camera returns to the standby mode.

Memo

- When [Save Interim Images] is set to [Unblended] or [Blended], a new folder is created and the images are saved there for each interval shooting.
- The second and later exposures start at the interval set in [Interval]. When the shutter speed is longer than the interval set in [Interval], the shooting result varies depending on the [Fixed Time Release] setting.

| Fixed Time Release | When the Shutter Speed Is Longer than the Interval Set in [Interval] |
|--------------------|--|
| On | Some shutter releases are skipped. Example) When [Interval] is set to 2 seconds, and the shutter speed is set to 3 seconds: The first exposure has not yet finished at the time the second exposure is supposed to be started (2 seconds after shooting has started), and so the second image is not taken. (Shooting ends before the images specified in [Number of Shots] are taken.) |
| Off | No shutter releases are skipped. Example) When [Interval] is set to 2 seconds, and the shutter speed is set to 3 seconds: The second exposure does not start even 2 seconds after shooting has started, and starts after the first exposure finishes. (Shooting ends after the images specified in [Number of Shots] are taken.) |

- When [Fixed Time Release] is set to [On], [Minimum] is not available for [Interval]. If [Interval] is set to [Minimum], the setting changes to [1sec].
- The time set by [Minimum] in [Interval] varies depending on the combination with the menu functions.
- Set the camera on a fixed support such as tripods during shooting.

Self-timer

- 1 Select **[Timer/Remote Control]** on the **[Drive Mode]** screen and press **▶**.
- 2 Use **▲▼** to select a setting.

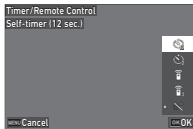

| | |
|--|---|
| | Performs self-timer shooting. (The shutter is released after about 12 seconds.) |
| | Performs self-timer shooting. (The shutter is released after about 2 seconds.) |

- 3 Press **OK**.
The camera returns to the standby mode.
- 4 Press **SHUTTER** halfway, and then fully.
The shutter is released after about 12 seconds or 2 seconds.

Memo

- The self-timer lamp blinks during the countdown for self-timer shooting. You can also make settings so that the lamp does not blink. (p.106)
- A beep sound is made during the countdown for self-timer shooting. You can also make settings so that a beep sound is not made. (p.106)
- During self-timer shooting, [Shake Reduction] of the 6 menu is automatically turned off. If you do not want to turn off the [Shake Reduction] function, make settings in [Auto Shake Reduction Off] of the 6 menu.

If Light Enters through the Viewfinder

When [Self-timer] or [Remote Control] is used, exposure may be affected by the light entering through the viewfinder. In such a case, use the AE Lock function or attach the optional ME viewfinder cap. Remove the eyecup before attaching the ME viewfinder cap.

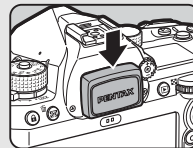

Remote Control



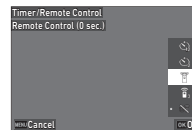







- 1 Select **[Timer/Remote Control]** on the **[Drive Mode]** screen and press **▶**.
- 2 Use **▲▼** to select a setting.



| | |
|--|--|
| | Performs shooting with the remote control unit. (The shutter is released immediately.) |
| | Performs shooting with the remote control unit. (The shutter is released after about 3 seconds.) |

- 3 Press **SHUTTER** halfway.
- 4 Point the remote control unit towards the remote control receiver of the camera, and press the shutter release button on the remote control unit.

Memo

- For  mode, make settings in [Remote Control] of the  menu.
- When shooting with the remote control unit is enabled, the lamp of the camera remote control receiver blinks. You can also make settings so that the lamp does not blink. (p.106)
- The eye sensor is disabled while [Remote Control] is selected.
- During shooting with the remote control unit, [Shake Reduction] of the  and  menu is automatically turned off. If you do not want to turn off the [Shake Reduction] function, make settings in [Auto Shake Reduction Off] of the  and  menu.
- The maximum operating distance of the remote control unit is about 4 m from the front of the camera, and about 2 m from the back of the camera.
- To adjust focus while shooting with the remote control unit, set [AF with Remote Control] to [On] in the  menu.
- When using the Remote Control Waterproof O-RC1, the autofocus system can be operated with the  button on the remote control unit. The  button cannot be used.
- The [Timer/Remote Control] setting is saved even after the power is turned off. If [Timer/Remote Control] is set to  (Off) in [Memory] of the  menu, the setting returns to [Off] when the power is turned off. (p.107)

Using a Flash

When an external flash (optional) is connected to the camera, you can discharge a flash for shooting.

Connecting a Flash

Remove the hot shoe cover from the camera, and attach an external flash.

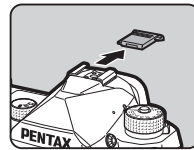

Memo

- Refer to “Functions when Using an External Flash” (p.115) for details on the functions of external flashes.



Setting the Flash Mode





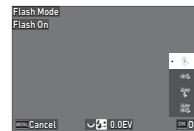

- 1 Select [Flash Mode] in the  2 menu and press .
The [Flash Mode] screen appears.



- 2 Select a flash mode.



| | | |
|---|-----------------------------|---|
|  | Auto Flash Discharge | Automatically measures the ambient light and determines whether to use the flash. |
|  | Auto Flash+ Red-eye | Discharges a pre-flash for red-eye reduction before an automatic flash. |

| | |
|--|---|
|  Flash On | Discharges a flash for each image. |
|  Flash On+Red-eye | Discharges a pre-flash for red-eye reduction before the main flash for each image. |
|  Slow-speed Sync | Sets to a slow shutter speed and discharges a flash for each image. Use this, for example, when shooting a portrait with the sunset in the background. |
|  Slow Sync+Red-eye | Discharges a pre-flash for red-eye reduction before the main flash is discharged with a slow shutter speed. |

Available operations

-  Compensates the flash exposure (-2.0 to +1.0).
-  Resets the compensation value to the default setting.

3 Press **OK**.

4 Press **MENU**.



The camera returns to the standby mode.

Memo



- The flash modes that can be selected vary depending on the capture mode.
- When the flash is used in **Av** mode, the shutter speed automatically changes over a range from 1/200 seconds to a slow shutter speed depending on the lens being used. The shutter speed is locked at 1/200 seconds when a lens other than a D FA, DA, DA L, FA, FA J, or F lens is used.
- When the flash is used in **Tv**, **TAv**, or **M** mode, any desired shutter speed of 1/200 seconds or slower can be set.

Controlling the Image Finishing Tone

Custom Image

 5 /  5

1 Press **▶** in the standby mode.

Alternatively, select [Custom Image] in the  5 or  5 menu.

The [Custom Image] screen appears.

2 Use **▲▼** to select an image finishing tone.

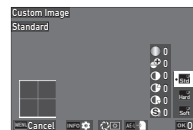

Standard
Hard

Soft

Available operations when shooting with the viewfinder

- Main switch to  Uses Digital Preview to preview the background image with the selected setting applied.
- AE-L** Saves the preview image (only when the image can be saved).

Proceed to Step 6 if you do not need to change the parameters.

3 Press **INFO**.

The parameter setting screen appears.

4 Set the parameters.



Available operations

-
- ▲▼ Selects a parameter.

 - ◀▶ Adjusts the value.

 - Switches between [Sharpness] and [Fine Sharpness].

 - Resets the adjustment value to the default setting.

5 Press **OK**.

The screen of Step 2 reappears.
The adjustment values for parameters are displayed.

6 Press **OK**.

The camera returns to the standby mode.

Caution

- In **AUTO** mode, the image finishing tone is fixed to [Standard].

Digital Filter

5 / 5

1 Select [Digital Filter] in the 5 or 5 menu and press **▶**.

The [Digital Filter] screen appears.

2 Use **▲▼** to select a filter.

Select [Off] to not shoot with a digital filter.

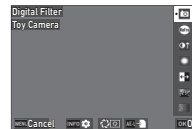

Toy Camera *1
Retro
High Contrast
Shading *1

Invert Color
Tone Expansion *1
Grainy Monochrome *1

*1 Not available in mode.

Available operations when shooting with the viewfinder

-
- Main switch to Uses Digital Preview to preview the background image with the selected effect applied.

 - AE-L** Saves the preview image (only when the image can be saved).

Proceed to Step 6 if you do not need to change the parameters.

3 Press **INFO**.

The parameter setting screen appears.

4 Set the parameters.

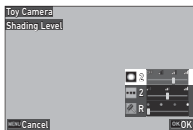

Available operations

▲▼ Selects a parameter.

◀▶ Adjusts the value.

5 Press **OK**.

The screen of Step 2 reappears.

6 Press **OK**.

7 Press **MENU**.

The camera returns to the standby mode.

⚠ Caution

- This function cannot be used in combination with some other functions. (p.111)
- Depending on the filter used, it may take longer to save images.

📌 Memo

- You can also process images with digital filters after shooting. (p.88)

Correcting Images

Adjusting the Brightness

Highlight Correction and Shadow Correction

📷5 / 📷15

You can reduce the occurrence of overexposed/underexposed areas by expanding the dynamic range and enabling a wider range of tones to be recorded by the CMOS sensor.

Make settings in [D-Range Correction] of the 📷5 or 📷15 menu.

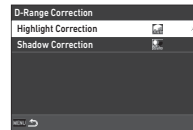

⚠ Caution

- When the ISO sensitivity is set to less than ISO 400, [Highlight Correction] cannot be set to [On].

📌 Memo

- In 📷 mode, [Highlight Correction] can be set to [Auto] or [Off].

You can take an image having wide dynamic range even in a scene where the dynamic range becomes narrow by taking three consecutive images at three different exposure levels and compositing them.

1 Select [HDR Capture] in the 3 menu and press .

The [HDR Capture] screen appears.

2 Select a capture type in [HDR Capture], and press .

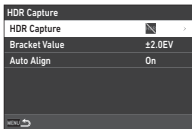

3 Set the range in which to change the exposure in [Bracket Value].

Select a range from [±1.0EV], [±2.0EV], and [±3.0EV].

4 Set whether to use [Auto Align] or not.

5 Press twice.

The camera returns to the standby mode.

Caution

- [HDR Capture] cannot be used in the following situations.
 - In **B** or **X** mode
 - In mode
- This function cannot be used in combination with some other functions. (p.111)
- When [Drive Mode] is set to [Interval Shooting] in the 3 menu, [Auto Align] is fixed to [Off].
- When [Auto Align] is set to [Off], [Shake Reduction] of the 6 menu is fixed to [Off].
- For HDR Capture, multiple images are combined together to create a single image, so it may take time to save the image.

The following corrections can be made in [Lens Correction] of the 5 menu.

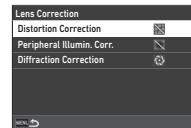

| | |
|----------------------------------|---|
| Distortion Correction | Reduces distortions occurring due to lens properties. |
| Peripheral Illumin. Corr. | Reduces peripheral light fall-off occurring due to lens properties. |
| Diffraction Correction | Corrects blur caused by diffraction when using a small aperture. |

Memo

- Corrections can only be made when a compatible lens is attached. (p.112) The corrections are disabled when using an accessory such as rear converters that is attached between the camera and the lens.
- When [File Format] is set to [RAW] or [RAW+JPEG] in the 4 menu, correction information is saved as a RAW file parameter. This correction information can be applied when developing a RAW image with [RAW Development] of the 4 menu. (p.89)

Adjusting the Image Quality Level and Texture

Reducing Moiré



By shaking the Shake Reduction unit, a moiré reduction effect simulating that of a low-pass filter can be achieved.

1 Select [AA Filter Simulator] in the menu and press **▶**.

2 Select a capture type and press **OK**.

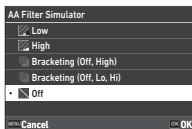

| | |
|----------------------------------|--|
| Low | Takes images while balancing the resolution and moiré reduction. |
| High | Prioritizes the moiré reduction. |
| Bracketting (Off, High) | Takes consecutive two images in order of [Off] and [High]. |
| Bracketting (Off, Lo, Hi) | Takes consecutive three images in order of [Off], [Low], and [High]. |

⚠ Caution

- This function cannot be used in combination with some other functions. (p.111)
- [Bracketting (Off, High)] and [Bracketting (Off, Lo, Hi)] cannot be selected in the following situations.
 - In **B** mode
 - When [Drive Mode] is set to other than [Single Frame Shooting] in the menu
 - While [HDR Capture] of the menu is used
 - When [Shutter Mode Selection] is set to [Electronic Shutter] in the menu
- When the shutter speed is faster than 1/1000 seconds, the full effect of this function cannot be achieved.

Adjusting the Texture



The texture and surface details of an image can be adjusted in the range of -4 to +4.

Make settings in [Clarity] of the menu.

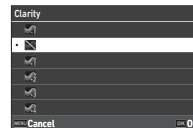

Reducing Blurring of Images

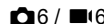

By using the built-in Shake Reduction unit of the camera, blurring of images can be reduced. Press **SR** or use [Shake Reduction] of the or menu to turn on and off this function.

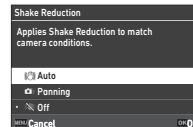

| | |
|----------------|--|
| Auto | Automatically switches between the normal Shake Reduction function and the Shake Reduction function specialized for panning. |
| Panning | Turns on the Shake Reduction function specialized for panning a slowly moving subject. |
| Off | Turns off the Shake Reduction function. |

In mode, select [On] or [Off].

📌 Memo

- [Shake Reduction] is fixed to [Off] in the following situations.
 - In **B** mode
 - When [Drive Mode] is set to [Mirror Lock-up Shooting], [Self-timer], or [Remote Control] in the menu
- To not turn [Shake Reduction] off while [Self-timer] or [Remote Control] of [Drive Mode] in the menu is used, set [Auto Shake Reduction Off] to [Disable Auto SR Off] in the or menu.
- You can set the camera operation when **SR** is pressed in [Shake Reduction] of [Fx Button] in the **C2** menu. (p.99)

⚠ Caution

- The operating noise of the Shake Reduction unit may be recorded during movie recording.

Correcting the Skew of Images



The horizontal camera angle detected by the electronic level can be corrected. Make settings in [Auto Horizon Correction] of the 6 menu.

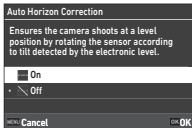

Fine-tuning the Composition



By using the Shake Reduction mechanism, the composition of the image can be fine-tuned. Use this function when you want to adjust the composition, such as when using a tripod while shooting with Live View.

1 Set [Composition Adjustment] to [On] in the 6 menu.

2 Press **MENU**.

The camera returns to the standby mode.

3 Set the /LV/ dial to **LV**.

The [Composition Adjustment] screen appears.

4 Adjust the composition.

The adjustment values are displayed at the top right of the screen.

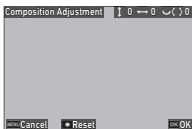

Available operations



Moves the composition of the image (up to 24 steps).



Corrects the tilt of the composition (up to 8 steps). (The tilt is not corrected when the amount of adjustment steps is 17 or more.)



Resets the adjustment value to the default setting.

5 Press **OK**.

The camera returns to the standby mode with Live View.

⚠ Caution

- [Composition Adjustment] cannot be used while [ASTROTRACER] of the 3 menu is used.

📌 Memo

- The adjusted composition is saved even if Live View is ended or the camera is turned off. To reset the saved adjustment value when the camera is turned off, set [Composition Adjustment] to (Off) in [Memory] of the 5 menu. (p.107)
- If [Composition Adjustment] is registered in [Fx Button] in the 2 menu, you can start the composition adjustment by pressing the button. (p.98)

Using the Playback Functions

You can select the playback functions from the **▶** menu (p.26) or on the "playback function selection screen".

Press **AE/L** in the playback mode to display the playback function selection screen. The functions of the **▶** 2 to **▶** 6 menus can be selected on the playback function selection screen.

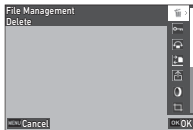

⚠ Caution

- The playback functions that are not supported by the displayed image cannot be used.

📌 Memo

- Even if a playback function is executed for an image, the shooting date of the image is not changed.

Setting the Operation in the Playback Mode

▶ 1

You can set the basic operation in the playback mode in the **▶** 1 menu.

The following settings can be made.

| | |
|--------------------------|------------------------------|
| Select Playback Card | SD1, SD2 |
| Auto Image Rotation | On, Off |
| Playback Order Options | File No., Shooting Date/Time |
| Playback Sound Volume | 0 to 40 |
| Touch Img. Browse Effect | On, Off |

📌 Memo

- The playback function is executed for the memory card in the slot selected in [Select Playback Card].

Changing the Playback Method

Displaying Multiple Images

You can display 20, 48, or 70 thumbnail images at the same time.

1 Turn to the left in the playback mode.

The multi-image display screen appears.

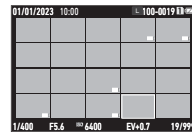

Available operations



Moves the selection frame.



Shows the next/previous page.



Changes the number of thumbnail images displayed on a page.



Switches between the SD1 card and the SD2 card.



Displays the playback function selection screen.



Deletes multiple images.

2 Press **OK**.

The selected image appears in the single image display.

Selecting Multiple Images

When multiple images are displayed, you can select images and execute the playback functions for them.

1 Press **MENU** or **AE** in Step 1 of “Displaying Multiple Images” (p.82).

The **▶** menu or playback function selection screen is displayed.

2 Use **▲▼** to select a function, and press **OK**.



3 Select images to execute the function for.



Available operations

| | |
|-------------|--|
| ▲▼◀▶ | Moves the selection frame. |
| OK | Confirms/cancels the selection of the image. |
| ☑ | Specifies the start and end points for image selection range. |
| ☺ | Shows the selected image in the single image display. Use ☺ to show a different image. |

4 Press **INFO**.

The confirmation screen appears.

5 Select **[Execute]** and press **OK**.

Memo

- You can execute the function for the images selected individually along with the images selected by specifying the range.
- Refer to the following pages for details on each function.
 - Delete (p.85)
 - Protect (p.86)
 - Image Copy (p.87)
 - File Transfer (p.87)
 - RAW Development (p.89)
- When a function that cannot be executed for multiple images is selected in Step 2, the selected function is applied to the image with the selection frame.
- When [File Transfer] is selected in Step 2, you can select [Transfer Reservation] or [Cancel Reservation]. Select [Transfer Reservation] to select the format of transferred files and make a transfer reservation. Select [Cancel Reservation] to cancel the transfer reservation for all images.

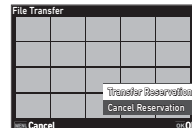

Displaying Images by Folder or Shooting Date





You can display images by folder where the images are saved or by shooting date, and execute a playback function for them. Whether the images are displayed by folder or by shooting date depends on the [Playback Order Options] setting in the **1** menu.

1 Turn to the left in Step 1 of “Displaying Multiple Images” (p.82).

The folder display screen or shooting date display screen appears.



Available operations

| | |
|--|---|
|  | Moves the selection frame. |
|  to the right | Displays the multi-image display screen. |
|  | Switches between the SD1 card and the SD2 card. |
|  | Displays the playback function selection screen. |
|  | Deletes the images by the selected folder or by the selected shooting date. |

2 Press **OK**.

The images in the selected folder or on the selected shooting date are displayed.

Memo

- When the playback function selection screen is displayed in Step 1, a function can be executed for all images in the selected folder or on the selected shooting date. If a function that cannot be executed for multiple images is selected, an error message is displayed.

Connecting the Camera to an AV Device

You can connect the camera to an AV device, such as a TV, equipped with an HDMI[®] terminal to display Live View images while shooting or to display images in the single image display in the playback mode.

Make sure to have a commercially available HDMI[®] cable equipped with an HDMI[®] terminal (Type D).

- 1 Turn the AV device and camera off.
- 2 Open the terminal cover of the camera, and connect the cable to the HDMI[®] terminal.

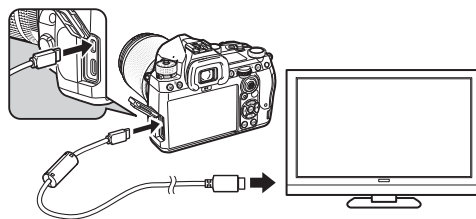

- 3 Connect the other end of the cable to the input terminal on the AV device.
- 4 Turn the AV device and camera on.

The camera turns on in the video output mode, and the camera information is displayed on the screen of the connected AV device.

Caution

- While the camera is connected to an AV device, nothing is displayed on the camera monitor. Also, you cannot adjust the sound volume on the camera. Operate the camera while viewing the monitor of the AV device.

Memo

- Check the operating manual of the AV device and select a suitable input terminal for connecting the camera.
- If you intend to use the camera continuously for a long period, the use of the optional AC adapter kit is recommended. (p.40)

Organizing Files

Deleting Images

▶ 2

- 1** Select **[Delete]** in the **▶ 2** menu or on the playback function selection screen.
- 2** Select **[Delete 1 Image]** or **[Delete All Images]**.
For images captured with [File Format] set to [RAW+JPEG], select the file format to delete.
When [Delete All Images] is selected, proceed to Step 4.
- 3** Use  to select an image.
- 4** Press **OK**.
When [Delete All Images] is selected, the confirmation screen appears. Proceed to Step 5.
- 5** Select **[Execute]** and press **OK**.



4

Playback

Protecting Images

▶ 2

You can protect images from being accidentally deleted.

1 Select **[Protect]** in the **▶ 2** menu or on the **playback function selection screen**.

2 Select **[Protect 1 Image]** or **[Protect All Images]**.

When **[Protect All Images]** is selected, proceed to Step 4.

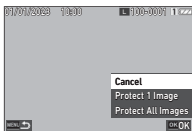

3 Use  to select an image.

4 Press **OK**.

When **[Protect All Images]** is selected, the confirmation screen appears. Proceed to Step 5.

5 Select **[Protect]** and press **OK**.

⚠ Caution

- Even protected images are deleted if the inserted memory card is formatted.

📝 Memo

- To cancel the protection for an image, set the protection for the image again.

Rotating Images

▶ 2

When **[Auto Image Rotation]** is set to **[On]** (default setting) in the **▶ 1** menu, the image is automatically rotated based on the rotation information during playback.

The rotation information of an image can be changed by following the procedure below.

1 Display the image to rotate in the **single image display**.

2 Select **[Image Rotation]** in the **▶ 2** menu or on the **playback function selection screen**.

3 Use **▲▼** to select the desired rotation direction and press **OK**.

The image rotation information is saved, and the camera returns to the single image display mode.

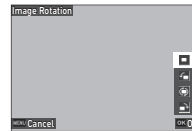

⚠ Caution

- You cannot change image rotation information in the following cases.
 - Protected images
 - Movies
 - Images without a rotation information tag

📝 Memo

- You can save the rotation information at a specific angle in **[Save Rotation Info]** of the **C6** menu.

Copying Images

▶ 2

You can copy images between memory cards in the SD1 slot and the SD2 slot.

1 Select [Image Copy] in the ▶ 2 menu or on the playback function selection screen.

2 Select [Copy 1 Image] or [Copy All Images].

For images captured with [File Format] set to [RAW+JPEG], select the file format to copy. When [Copy All Images] is selected, proceed to Step 4.

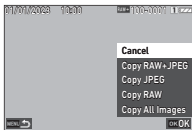

3 Use  to select an image.

4 Press **OK**.

When [Copy All Images] is selected, select [Execute] and press **OK**.

The selected image is copied to the other memory card.

Transferring Images

▶ 2

You can select images to transfer to a communication device and make a transfer reservation. When the camera is connected to a communication device via a wireless LAN, the file transfer automatically starts.

1 Select [File Transfer] in the ▶ 2 menu or on the playback function selection screen.

2 Select [Transfer 1 Image].

For images captured with [File Format] set to [RAW+JPEG], select the file format to transfer.

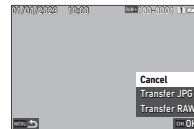

3 Use  to select an image.

4 Press **OK**.

The transfer reservation is made for the image.



Memo

- To cancel the transfer reservation, select [Transfer 1 Image] again.

4

Playback

Saving the RAW Data



You can save the RAW data when it remains in the buffer of the captured JPEG image.

1 Select [Save RAW Data] in the 2 menu in the single image display.

The confirmation screen appears.

When no JPEG images have RAW data, the message [No image can be processed.] is displayed.

2 Select [Save RAW Data] and press **OK**.

The RAW data is saved.

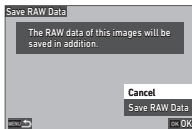

⚠ Caution

- The RAW data cannot be saved from the playback function selection screen.

📝 Memo

- When a JPEG image that has RAW data is displayed in the single image display, you can also save the data by pressing **RAW**.
- The images for which [Save RAW Data] is executed are treated the same as the images captured with [File Format] set to [RAW+JPEG] in the 4 menu.

Editing and Processing Images

You can edit and process the images captured with the camera.

Processing Images with Digital Filters 3

1 Display the image to edit in the single image display.

2 Select [Digital Filter] in the 3 menu or on the playback function selection screen.

The [Digital Filter] screen appears.

3 Use to select a filter.

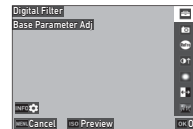

Base Parameter Adj

Toy Camera

Retro

High Contrast

Shading

Invert Color

Tone Expansion

Grainy Monochrome

Miniature

Soft

Fish-eye

Slim

Frame Composite

Available operations

ISO

Displays the preview.

Proceed to Step 7 if you do not need to change the parameters.

4 Press **INFO**.

The parameter setting screen appears.

5 Set the parameters.

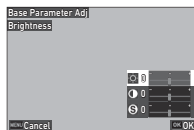

Available operations

▲▼ Selects a parameter.

◀▶ Adjusts the value.

6 Press **OK**.

The screen of Step 3 reappears.

7 Press **OK**.

The filter addition confirmation screen appears.

8 Select **[Add Filter]** or **[Save]**, and press **OK**.

Select [Add Filter] when you want to apply additional filters to the same image.

The screen of Step 3 reappears.

When [Save] is selected, the save confirmation screen appears.

9 Select **[SD1]** or **[SD2]**, and press **OK**.

⚠ Caution

- Only JPEG and RAW images captured with this camera can be edited with [Digital Filter].
- RAW images captured using [HDR Capture] of the **3** menu cannot be processed with [Digital Filter].

📝 Memo

- Up to seven filters, including the filter used during shooting that is set in [Digital Filter] of the **5** menu (p.77), can be applied to the same image.

Developing RAW Images

▶ 4

You can convert RAW images into the JPEG or TIFF format and then save them as new files.

1 Display the image to edit in the single image display.

2 Select **[RAW Development]** in the **4** menu or on the playback function selection screen.

The RAW development setting screen appears.

3 Select the setting item to change.

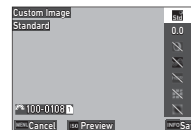

| | |
|---------------------------|--------------------------|
| Custom Image | High-ISO Noise Reduction |
| Sensitivity | Shadow Correction |
| Digital Filter | File Format |
| Clarity | JPEG Recorded Pixels |
| HDR Capture | JPEG Quality |
| Distortion Correction | Aspect Ratio |
| Peripheral Illumin. Corr. | Color Space |
| Diffraction Correction | |

Available operations

☽ Selects a different image.

▲▼ Selects a setting item.

▶ Makes detailed settings.

ISO Displays the preview.

4 Press **INFO**.

The save confirmation screen appears.

4

Playback

- 5** Select [SD1] or [SD2], and press **OK**.
- 6** Select [Continue] or [Finish], and press **OK**.
When [Continue] is selected, the screen of Step 3 reappears.

⚠ Caution

- [RAW Development] can be executed only for RAW images captured with this camera.
- The RAW images captured when [Drive Mode] is set to [Multi-exposure] or [Interval Composite] in the **3** menu are developed according to the [Lens Correction] setting used during shooting. The [Lens Correction] setting cannot be changed when developing the RAW images.

📝 Memo

- When [RAW Development] is executed from the multi-image display screen, folder display screen, or shooting date display screen, a new folder is created, and the images are stored in it.
- For [Digital Filter], [Clarity], and [HDR Capture], the setting item of which parameters can be changed varies depending on the item used during shooting. For the RAW images captured using [HDR Capture], you cannot change the parameters of [Digital Filter] and [Clarity] when developing the RAW images.
- With the provided software “Digital Camera Utility 5”, you can develop RAW images on a computer. (p.94)

Changing the Image Size

⚠ Caution

- Images already resized or cropped to the minimum file size cannot be processed.

Changing the Number of Recorded Pixels (Resize)



You can change the number of recorded pixels of the selected image, and save it as a new file.

- 1** Display the image to edit in the single image display.
- 2** Select [Resize] in the **5** menu or on the playback function selection screen.
The [Resize] screen appears.
- 3** Use **▲▼** to select the number of recorded pixels and press **OK**.
You can select an image size smaller than that of the original image.
The save confirmation screen appears.

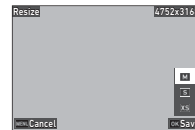

- 4** Select [SD1] or [SD2], and press **OK**.

⚠ Caution

- [Resize] can be executed only for JPEG images captured with this camera.

Cropping Out Part of the Image (Cropping) ▶ 3

You can crop out only the desired area of the selected image, and save it as a new file.

- 1 Display the image to edit in the single image display.
- 2 Select [Cropping] in the ▶ 3 menu or on the playback function selection screen.
The [Cropping] screen appears.
- 3 Specify the size and position of the area to crop by using the cropping frame.

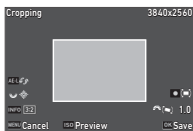

Available operations

| | |
|--|---|
| | Changes the size of the cropping frame. |
| | Moves the cropping frame. |
| | Changes the aspect ratio. |
| | Rotates the image by 0.1°. |
| | Rotates the cropping frame by 90° (only when possible). |
| | Resets the rotation settings. |

- 4 Press **OK**.
The save confirmation screen appears.
- 5 Select [SD1] or [SD2], and press **OK**.

Correcting JPEG Images ▶ 5

Correcting Highlight/Shadow Areas (Levels Adjustment)

You can adjust the brightness and contrast of the highlight, mid-tone, and shadow areas in images.

- 1 Display the image to edit in the single image display.
- 2 Select [Levels Adjustment] in the ▶ 5 menu or on the playback function selection screen, and press **▶**.
The [Levels Adjustment] screen appears.
- 3 Adjust the value.

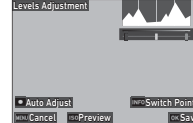

Available operations

| | |
|--|----------------------------------|
| | Switches the adjustment points. |
| | Adjusts the value. |
| | Automatically adjusts the value. |
| | Displays the preview. |

- 4 Press **OK**.
The save confirmation screen appears.
- 5 Select [SD1] or [SD2], and press **OK**.

- 1 Display the movie to edit in the single image display.
- 2 Select [Extract Movie] or [Divide Movie] in the ▶ 6 menu or on the playback function selection screen.

| | |
|---------------|--|
| Extract Movie | Saves the range specified with the start and end points as a new file. |
| Divide Movie | Divides a movie into two files at the specified division point and saves as new files. |

- 3 Press **OK**.
The [Extract Movie] screen or [Divide Movie] screen appears.

- 4 Select the point where you want to divide the movie.
You can play or pause the movie in the same manner as when playing back a movie. (p.56)

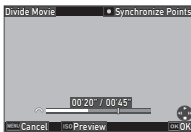
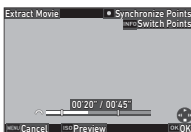

Available operations



When [Extract Movie] is selected: Moves the start or end point.

When [Divide Movie] is selected: Moves the division point.



When [Extract Movie] is selected: Switches between the start and end points.



Synchronizes the points.



Displays the preview.

- 5 Press **OK**.
The save confirmation screen appears.

- 6 Select [SD1] or [SD2], and press **OK**.

Caution

- Only movies recorded with this camera can be edited.

Using the Camera with a Computer

Connect the camera to a computer using the provided USB cable.

Setting the Connection Mode



Set the connection mode in [USB Setting] of the 4 menu according to the operation to be performed with a computer.

| | |
|---------------------------------|--|
| MTP (default setting) | Allows you to copy the data in the memory card to a computer or perform tethered shooting by operating the camera with a computer. The memory card is displayed on the computer. |
| CD-ROM | Allows you to install the provided software stored in the internal memory. (p.94) The software is displayed as the software installation CD-ROM [S-SW189] on the computer. |

Memo

- Refer to "Operating Environment for USB Connection and Provided Software" (p.127) for system requirements to connect the camera to a computer and use the provided software.
- The following functions are disabled while the camera is connected to a computer with a USB cable.
 - [Wireless LAN Setting] of the 4 menu
 - [Auto Power Off] of the 5 menu

Copying an Image on the Memory Card

- 1 Turn the camera off.
- 2 Open the terminal cover of the camera, and connect the USB cable to the USB terminal.

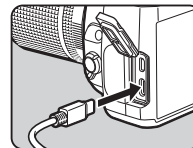

- 3 Connect the USB cable to the USB port of the computer.

- 4 Turn the camera on.

The camera is recognized by the computer.

For Mac, the app "Photos" starts. (When the app does not start, start it manually.)

- 5 Save the captured images to the computer.
- 6 Disconnect the camera from the computer.



Memo

- Charging of the battery starts when the camera is turned off after it is connected to the computer.
- On the computer, the memory cards are displayed as [SD1] and [SD2].

Installing the Provided Software

The provided software “Digital Camera Utility 5” is stored in the internal memory of the camera. With “Digital Camera Utility 5”, you can develop RAW images, make color adjustments, or check shooting information on the computer.

The software can be installed by following the procedure below.



- 1** Set [USB Setting] to [CD-ROM] in the  4 menu.
- 2** Turn the camera off.
- 3** Connect the camera to a computer using a USB cable.
- 4** Turn the camera on.
The camera is recognized as CD-ROM [S-SW189].
- 5** Open [S-SW189] on the computer.
The [Win] or [Mac] folder appears.
- 6** Open the [Win] or [Mac] folder.
- 7** Double-click [setup32.exe] or [setup64.exe] for Windows®, or [INSTPUT5.pkg] for Mac.
For subsequent steps, follow the on-screen instructions.
- 8** Return [USB Setting] to [MTP] in the  4 menu.
- 9** Turn the camera off and back on.
The [USB Setting] setting switches to [MTP].

Operating the Camera with a Computer

You can perform tethered shooting with the camera connected to a computer using the optional “IMAGE Transmitter 2”.

- 1** Set [USB Setting] to [MTP] in the  4 menu.
- 2** Turn the camera off.
- 3** Connect the camera to a computer using a USB cable.
- 4** Turn the camera on.
- 5** Start “IMAGE Transmitter 2” on the computer.
“IMAGE Transmitter 2” is started and the computer recognizes the camera.

Caution

- When the  /LV/  dial is set to , tethered shooting is not available until a memory card is inserted to the camera.

Memo

- “IMAGE Transmitter 2” supports Windows® only. For details, download and refer to the latest version of the “User Guide [Operation]” available at the following website.
https://www.ricoh-imaging.co.jp/english/support/download_manual.html
- During tethered shooting, the camera always operates with [Release-priority] regardless of the autofocus settings ([AF.S Setting] of [AF with Viewfinder] and [Contrast AF Options] of [AF with Live View] in the  1 menu). (p.60, p.63)

Using the Camera with a Communication Device

You can connect the camera to a communication device wirelessly via Bluetooth® or wireless LAN. By using the dedicated app “Image Sync”, the camera can be operated from the communication device and the images saved in the memory cards can be displayed on the communication device to import them.

Refer to the separate “Wireless Communication Guide” for how to use the camera connected with a communication device.

Camera Settings

Saving Frequently Used Settings

C1

You can save up to ten frequently used settings and assign the settings to **U1** to **U5** of the mode dial so that you can easily use the settings for shooting.

The following settings can be saved.

| | |
|---|---|
| Exposure mode (except for AUTO) | Exposure value compensation |
| Shutter speed and aperture value | ☑ menu and C menu settings (with exceptions) |
| ISO sensitivity | |

Saving the Settings

You can save up to ten settings.

1 Set the exposure mode and all the necessary settings to save.

2 Select [Save User Mode Settings] in the **C1** menu and press **▶**.

The [Save User Mode Settings] screen appears.

3 Select a box from [**BOX1**] to [**BOX10**], and press **OK**.

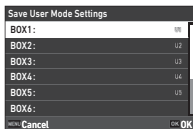

4 Select whether to enter the box name and press **OK**.

When [Cancel] is selected, proceed to Step 7.

When [Enter Name] is selected, the text-entry screen appears.

5 Enter the box name.

Up to 32 single-byte alphanumeric characters and symbols can be entered.



Available operations

| | |
|------|---|
| ▲▼◀▶ | Moves the cursor. |
| ☑ | Switches between upper and lower case letters. |
| ISO | Switches between alphabetical and numeric characters. |
| OK | Enters a character at the position of the cursor. |
| ☒ | Deletes a character from the entered text. |

6 After entering the text, press **INFO**.

7 Select a user mode to register the saved settings to from **USER1 (U1)** to **USER5 (U5)** of the mode dial, and press **OK**.

The screen of Step 3 reappears.

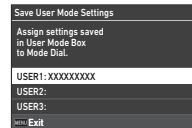

⚠ Caution

- [Save User Mode Settings] cannot be selected when the mode dial is set to **AUTO**.

📌 Memo

- If the box name is not entered, the date and time when the settings are saved are used as the box name.
- To change the box name, select [Rename User Mode] in the **C1** menu.
- To reset the saved settings, select [Reset User Mode Settings] in the **C1** menu.

Changing the Settings

You can change the settings assigned to the mode dial.

1 Select [Recall User Mode Setting] in the **C1** menu and press **▶**.

The [Recall User Mode Setting] screen appears.

2 Select a user mode to register the saved settings to from **USER1 (U1)** to **USER5 (U5)** of the mode dial, and press **▶**.

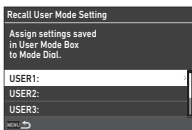

3 Select the saved settings from **[BOX1]** to **[BOX10]**, and press **OK**.

The selected settings are assigned to the mode dial.

The screen of Step 2 reappears.

● Memo

- If [Recall User Mode Setting] is registered as a function displayed in the control panel, you can use  to change the box when the mode dial is set to **U1** to **U5**. (p.102)

Using the User Mode

1 Set the mode dial to **U1** to **U5**.

2 Change the settings as necessary.

The exposure mode can be temporarily changed in [Exposure in User Mode] of the **C1** menu.

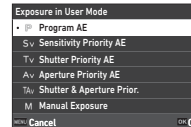

● Memo

- The settings changed in Step 2 are not saved as the user mode settings. When the camera is turned off or the mode dial is turned, the user mode settings are reset to the originally saved ones. The timing to reset the user mode settings can be set in [User Settings Restoration] in the **C1** menu.

| Setting | When the camera is turned off | When the mode dial is turned |
|---------|-------------------------------|------------------------------|
| Type 1 | Reset | Not reset |
| Type 2 | Not reset | Reset |
| Type 3 | Reset | Reset |

- If the settings saved in the box assigned to the mode dial are changed, the settings applied to the mode dial are also changed.

Customizing the Operating Controls

Setting the Button Operation

C2

You can set the functions for when **▲▼◀▶**, **SR**, **RAW**, **🔒**, **📷**, **📺**, or **AE-L** is pressed. These customizable buttons are called “Fx button”.

The function set for each button can be checked on the status screen.

1 Select [Fx Button] in the C2 menu and press ▶.

The [Fx Button] screen appears.

2 Use ▲▼ to select a button and press ▶.

The screen to set the function for the selected button is displayed.



3 Use ▲▼ to select the function to assign to each button.

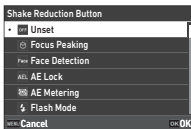

The following functions can be assigned.

| | |
|------------------------------------|--------------------------------------|
| Focus Peaking | Shake Reduction ^{*3} |
| Face Detection | Auto Horizon Correction |
| AE Lock | Composition Adjustment ^{*4} |
| AE Metering | Operation Control Lock ^{*3} |
| Flash Mode | One Push LV ^{*5} |
| Drive Mode | Monitor Touch Operation |
| Drive | Viewfinder Light |
| Bracketing ^{*1} | LCD Panel Illumination |
| Timer/Remote Control | Electronic Level Display |
| HDR Capture | Playback Mode |
| AA Filter Simulator | Outdoor View Setting |
| One Push File Format ^{*2} | Night Vision Display |
| Crop ^{*3} | Wireless LAN Setting |
| Custom Image | |

*1 Changes the number of shots and bracket value.

*2 Changes the file format according to the [File Format] setting when the button is pressed. (p.99)

*3 Press **INFO** to make detailed settings.

*4 Displays the [Composition Adjustment] screen when the **📷/LV** dial is set to **LV**.

*5 Switches to shooting with Live View while keeping the **📷/LV** dial set to **📷**.

4 Press **OK**.

The screen of Step 2 reappears.
Repeat Steps 2 to 4.

5 Press **MENU** twice.

Memo

- You can check the functions assigned to each button on the status screen.
- You can set the same function to multiple buttons.
- The setting switches or the setting screen appears when the Fx button is pressed.
- Depending on the assigned function, a beep sounds when the Fx button is pressed. To not make a beep sound, change the [Fx Button Operation] setting of [Sound Effects Setting] in the **3** menu. (p.106)
- When [Crop], [Shake Reduction], or [Operation Control Lock] is assigned to the Fx button, press **INFO** on the screen of Step 2 to set the camera operation when the button is pressed.



| | |
|-------------------------------|---|
| Crop | OFF→1.3x→1.7x OFF→1.3x OFF→1.7x |
| Shake Reduction | OFF→AUTO→PAN (panning) AUTO→PAN (panning) OFF→AUTO OFF→PAN (panning) |
| Operation Control Lock | Exposure Change Lock (shutter speed, aperture value, ISO sensitivity, EV Compensation, INFO , AE Lock) Misoperation Prevention (▲▼◀▶, INFO , MENU) |

Setting the One Push File Format

You can temporarily change the file format by pressing the button during shooting. Select the file format to change to when the button is pressed for each [File Format] setting.

1 Select [One Push File Format] in Step 3 of “Setting the Button Operation” (p.98).

2 Press **INFO** on the [Fx Button] screen.

The [One Push File Format] screen appears.

3 Make the [JPEG Options], [RAW Options], and [RAW+JPEG Options] settings.

Select the file format to change to when each button is pressed.

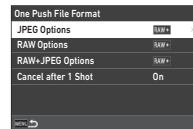

4 Make the [Cancel after 1 Shot] setting.

| | |
|------------|---|
| On | The file format returns to the [File Format] setting in the 4 menu after an image is taken. |
| Off | The file format is retained until any of the following operations is performed. <ul style="list-style-type: none"> Turning the camera off Switching the user modes Setting the camera to the playback mode Setting the camera to the INFO mode |

5 Press **MENU** twice.

The camera returns to the standby mode.

Caution

- The button to which the One Push File Format function is assigned cannot be used when [Memory Card Options] is set to [Separate RAW/JPEG] in the **4** menu. (p.47)

Setting the Autofocus and AE Lock Operations **C2**

You can set the button operations and timing for autofocus and AE Lock in [AF/AE Lock Settings] of the **C2** menu. The following settings can be made for [Still Image].

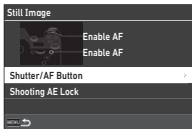

| | |
|--------------------------|---|
| Shutter/AF Button | Sets the operations when SHUTTER is pressed halfway or AF is pressed. |
| Shooting AE Lock | Sets the timing to lock the exposure value. |

In **■** mode, the **AF** function is fixed to the autofocus operation. Set whether to perform autofocus with **SHUTTER**.

Memo

- When a lens that is capable of AF tracking is attached to the camera, you can turn on and off the tracking operation by pressing **OK** during movie recording.

Setting the E-dial Operation **C2**

For each exposure mode, you can set the functions for when or is turned, when **■** is pressed, and when [E-Dial] is set for the Smart Function and is turned.

1 Select [E-Dial Programming] in the **C2** menu and press **▶**.

The [E-Dial Programming] screen appears.

2 Select [Still Image] or [Movie], and press **▶**.

The exposure mode selection screen appears.

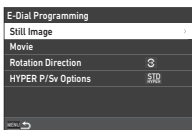

3 Use **◀▶** to select an exposure mode and press **OK**.

The current settings are displayed.

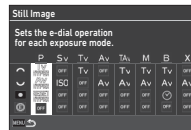





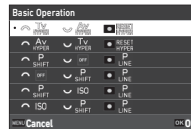

4 Select [Basic Operation] and press **▶**.



5 Use **▲▼** to select the combination of functions for when , , or is turned and when **■** is pressed.



| | |
|-----------------|--|
| Tv | Changes the shutter speed. |
| Tv SHIFT | Shifts the shutter speed. |
| Av | Changes the aperture value. |
| Av SHIFT | Shifts the aperture value. |
| ISO | Changes the ISO sensitivity. |
| ISO AUTO | Automatically adjusts the ISO sensitivity. |
| Sv SHIFT | Shifts the ISO sensitivity. |
| + | Compensates the exposure value. |
| RESET | Resets the compensated exposure value. |

| | |
|---|---|
|  | Executes the Program Shift. |
|  | Executes the Program Line. |
|  | Sets the camera to the hyper mode. |
|  | Sets the camera to the advanced hyper mode. |
|  | Cancels the hyper mode. |
|  | Enables/Disables the timed exposure. |
|  | Not available |

6 Press **OK**.

The screen of Step 4 reappears.

When [E-Dial] is set for the Smart Function, make the [S.Fn Dial (E-Dial)] setting.



7 Press **MENU**.

The screen of Step 3 reappears.

Repeat Steps 3 to 7.

8 Press **MENU** three times.

Memo

- You can check the functions assigned to each dial on the status screen.
- When assigning a function to , assign [E-Dial] to [Smart Function] in the **C2** menu. (p.102)
- If you select [Rotation Direction] on the screen of Step 2, you can reverse the effect obtained by turning  or .
- If you select [HYPER P/Sv Options] on the screen of Step 2, you can set the camera operation when the camera enters the hyper mode in **P** or **Sv** mode.

| | |
|-----------------|--|
| Standard | Determines the exposure by prioritizing the last changed shutter speed and aperture value. |
| Advanced | Fixes the changed exposure parameters: ISO sensitivity, shutter speed, and aperture value. When all parameters are changed, the camera enters the hyper M mode. |

Setting the Smart Function

C2

You can register five functions for the Smart Function.

- 1 Select **[Smart Function]** in the **C2** menu and press **▶**.

The [Smart Function] screen appears.

- 2 Select a function number from **[Function 1]** to **[Function 5]**, and press **▶**.

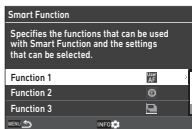

- 3 Use **▲▼** to select the function to assign to each function number.

The following functions can be assigned.

Up to six settings can be registered for a function. The order of the settings can also be registered.

| | |
|-----------------------------|------------------------|
| Unset | Program Line *2 |
| User AF *1 *2 | Drive *2 |
| AF Mode | AA Filter Simulator *2 |
| AF Active Area *2 | HDR Capture *2 |
| Hold AF Status *2 | Crop *2 |
| Focus Peaking *2 | Custom Image *2 |
| AE Metering *2 | Shake Reduction *2 |
| E-Dial *3 | Zoom Review |
| ISO Sensitivity | Grid Guide |
| EV Compensation | Outdoor View Setting |
| Flash Exposure Compensation | |

*1 The camera operates with the [AF Mode], [AF Active Area], and [Hold AF Status] settings made in advance in [AF with Viewfinder].

*2 Press **[INFO]** to make detailed settings.

*3 You can change the ISO sensitivity and exposure compensation values between the values registered in advance for each exposure mode by turning **○**.

- 4 Press **OK**.

The screen of Step 2 reappears.

Repeat Steps 2 to 4.

- 5 Press **MENU** twice.

Customizing the Control Panel

C5

You can customize the functions displayed on the control panel. Some functions in the **Ⓜ**, **■**, and **Ⓛ** menus can be saved as control panel items.

- 1 Select **[Control Panel]** in the **C5** menu and press **▶**.

- 2 Select **[Still Image]** or **[Movie]**, and press **▶**.

The control panel customization screen appears.

- 3 Use **▲▼◀▶** to select the function to change.

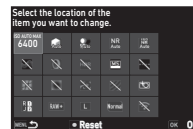

- 4 Press **OK**.

Selectable functions are displayed in the pop-up menu.

- 5 Use **▲▼** to select the function to save.

Select **[--]** if you do not want to save any function.

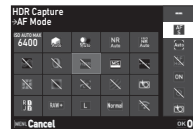

- 6 Press **OK**.

The screen of Step 3 reappears.

Press **■** to reset to the default functions.

- 7 Press **MENU** three times.

Memo

- When the control panel is displayed from the standby mode, you can display the screen of Step 3 by pressing **Ⓜ** to customize the control panel.

Setting the Monitor Display, Indicator Lamp Illumination, and Sound Effects

Eye Sensor

C4

You can set the camera operation when the eye sensor detects the user's eye in [Eye Sensor] of the **C4** menu.

| | |
|------------------------------|---|
| Link Monitor Display | Turns off the monitor backlight when the eye sensor detects the user's eye. |
| AE with Eye Sensor | Starts metering when the eye sensor detects the user's eye. |
| Detection Sensitivity | Sets the eye sensor detection sensitivity. |

Viewfinder Display

C4

You can set the display in the viewfinder in [Viewfinder Display] of the **C4** menu.

| | |
|---------------------------------|--|
| Viewfinder Screen | Sets the combination of display items from among the grid guide, electronic level, AF frame, spot metering frame, AF points, and Smart Function icons (p.103). |
| Electronic Level Type | Sets the electronic level type to [Level+Tilt] or [Level]. |
| Viewfinder Light | Sets whether to illuminate the viewfinder. When [Auto] is set, the viewfinder is illuminated only in dark places. |
| Info Display Outside FOV | Sets whether to display information such as the exposure value outside the field of view in the viewfinder. |

Setting the Viewfinder Screen Display

You can switch the viewfinder display between the registered four patterns. You can also change the items to display for each pattern.

1 Select [Viewfinder Screen] in [Viewfinder Display] of the C4 menu, and press ►.

The [Viewfinder Screen] screen appears.

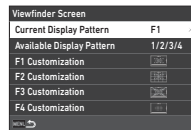

2 Select [Current Display Pattern] and press ►, and select a pattern from F1 to F4.

3 When customizing the display items, select [F1 Customization] to [F4 Customization], and press ►.

The grid style can be selected, and the display of each item can be turned on and off.

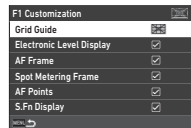

4 Press **MENU** four times.

Memo

- You can easily switch the viewfinder screen patterns using the Smart Function or control panel. If there are patterns that you do not want to use, select [Available Display Pattern] on the screen of Step 2 and set them to (Off).

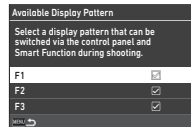

6

Settings

LCD Panel

C4

You can set the illumination of the LCD panel in [LCD Panel] of the **C4** menu.

| | |
|--------------------------------|---|
| Illumination Brightness | Sets the brightness to [Low] or [High]. |
| LCD Panel Illumination | [Auto]: Illuminates the LCD panel when the metering is started while shooting with the viewfinder. [Manual]: Illuminates the LCD panel when the button to which [LCD Panel Illumination] is assigned in [Fx Button] of the C2 menu is pressed. [Off]: Does not illuminate the LCD panel. |

6

Settings

Monitor Display

C4

You can set the information displayed on the monitor in [Monitor Display] of the **C4** menu.

| | |
|------------------------------|--|
| Color Settings | Sets [Color] and [Style] of the status screen and control panel. |
| Status Screen | Sets [Auto Display Rotation], [Electronic Level Display], [Electronic Level Type], and [Electronic Level Design]. |
| Live View | Sets [Shooting Info Display], [Electronic Level Type], [Electronic Level Design], and [Flicker Reduction]. |
| Playback Info Display | Sets the information to display when the screen is switched with INFO in the playback mode. |
| Grid Guide | Sets [Grid Style] and [Grid Color] of the grid lines displayed while shooting with Live View and in the playback mode. |

Setting the Live View Display

You can switch the Live View display between the registered three patterns. You can also change the items to display for each pattern.

1 Select [Live View] in [Monitor Display] of the **C4** menu, and press **▶**.

The [Live View] screen appears.

2 Select [Shooting Info Display] and press **▶**.

3 Select [Current Display Pattern] and press **▶**, and select a pattern from L1 to L3.

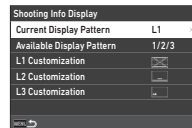

4 When customizing the display items, select [L1 Customization] to [L3 Customization], and press **▶**.

The display of each item can be turned on and off.

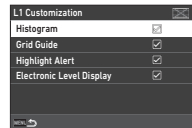

5 Press **MENU** four times.

Memo

- You can switch the Live View shooting information display by pressing **INFO** during shooting. If there are patterns that you do not want to use, select [Available Display Pattern] on the screen of Step 3 and set them to (Off).

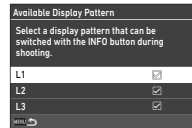

Monitor Adjustment



You can set the brightness, saturation, and color balance of the monitor.

1 Select [Monitor Adjustment] in the 2 menu and press **▶**.

The monitor adjustment screen appears.

2 Set each item.



Available operations

| | |
|--|--|
| | Selects the item. |
| | Adjusts the value. |
| | [Brightness]: Switches between the automatic adjustment and the manual adjustment. |
| | Resets the adjustment value to the default setting. |

3 Press **OK**.

⚠ Caution

- [Brightness] cannot be set when the monitor brightness is adjusted with [Outdoor View Setting] of the 2 menu.

📝 Memo

- The eye sensor is used when the automatic adjustment (default setting) is selected for [Brightness]. If the eye sensor is in the shade or exposed to strong light, the brightness may not be adjusted correctly. To not change the brightness automatically, use the manual adjustment.

Instant Review

C4

You can set the display and operation of “Instant Review” that is displayed immediately after shooting in [Instant Review] of the **C4** menu.

| | |
|----------------------------------|--|
| Display Time | Sets the Instant Review display time. When [Display Time] is set to [Hold], Instant Review is displayed until the next operation. |
| Zoom Review | Displays the magnified image with during Instant Review. |
| Save RAW (RAW Button) | Saves the RAW data with RAW during Instant Review. |
| Delete Img. (Delete Btn.) | Deletes the displayed image with during Instant Review. |
| Manage Img. (AE-L Btn.) | Displays the file management screen (for [Delete], [Save RAW Data], [Protect], and [Transfer Reservation]) with AE-L during Instant Review. |
| Histogram | Displays the histogram during Instant Review. |
| Highlight Alert | Displays the highlight alert during Instant Review. |

Zoom Review

C4

You can set the camera operation when the display is zoomed in [Zoom Review] of the **C4** menu.

| | |
|----------------------------|---|
| Quick Zoom | [Display Magnification]: Sets the display magnification for the quick zoom function. [Zoom Trigger]: Sets the trigger operation for the quick zoom function. |
| Focus Magnification | Zooms the display centering on the focused point. |

Warning Display

C4

You can set whether to display the warning icon in the viewfinder and on the LCD panel and monitor in [Warning Display] of the **C4** menu.

| | |
|---------------------------------|---|
| Release Lock Warning | Displays the warning icon when the shutter cannot be released because there is no available space on the memory card or due to other problems. |
| Release Timer Warning | Displays the warning icon when the shutter cannot be released immediately because [Timer/Remote Control] is turned on in [Drive Mode] of the C3 menu or due to other problems. |
| Image Processing Warning | Displays the warning icon when a function for which the image processing takes a long time after shooting, such as [HDR Capture] in the C3 menu, is enabled. |

Indicator Lamps

3

You can set whether to light up the indicator lamps in [Indicator Lamps] of the **3** menu.

| | |
|-----------------------|---|
| Self-timer | Makes the indicator lamps blink during the countdown for shooting with [Self-timer (12 sec.)], [Self-timer (2 sec.)], or [Remote Control (3 sec.)] in [Drive Mode] of the C3 menu. |
| Remote Control | Makes the indicator lamps blink during the standby for shooting with [Remote Control] in [Drive Mode] of the C3 menu. |
| GPS Unit | Lights up the indicator lamps when the GPS unit is attached to the camera. |

Sound Effects

3

You can set the sound volume of beep sounds in [Sound Effects Volume] (0 to 5), and set whether to make beep sounds in [Sound Effects Setting] of the **3** menu.

| | |
|---------------------------------|--|
| Electronic Shutter Sound | Makes an electronic shutter sound while shooting with [Shutter Mode Selection] set to [Electronic Shutter] in the C3 menu. |
| In-focus | Makes a beep sound when the subject is focused. |
| AE Lock | Makes a beep sound when the exposure value is locked. |
| Count Down | Makes a beep sound during the countdown for shooting with [Self-timer] or [Remote Control (3 sec.)] in [Drive Mode] of the C3 menu. |
| Mirror Up | Makes a beep sound during the mirror lock-up shooting with [Mirror Lock-up Shooting] in [Drive Mode] of the C3 menu. |
| Fx Button Operation | Makes a beep sound when the Fx button is pressed, to which [One Push File Format], [Crop], [Shake Reduction], [Auto Horizon Correction], [Monitor Touch Operation], [Viewfinder Light], [LCD Panel Illumination], [Electronic Level Display], [Night Vision Display], or [Wireless LAN Setting] is assigned. |

Selecting Settings to Save in the Camera

C5

The setting values for most functions of this camera are saved even if the camera is turned off. For the following function settings, you can select whether to save the settings (☑: On) or to return the settings to their default values (☐: Off) when the camera is turned off. Make settings in [Memory] of the C5 menu.

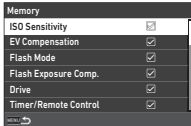

| | |
|-----------------------------|------------------------|
| ISO Sensitivity | Clarity |
| EV Compensation | Composition Adjustment |
| Flash Mode | Shooting Info Display |
| Flash Exposure Compensation | Playback Info Display |
| Drive | Image for Playback |
| Timer/Remote Control | Operation Control Lock |
| HDR Capture | Outdoor View Setting |
| Crop | Night Vision Display |
| Custom Image | Focus Limiter |
| Digital Filter | |

🌀 Memo

- When [Reset] of the 8 menu is performed, all [Memory] settings return to the default values.

File Management Settings

Specifying the Folder/File Settings

1

Create New Folder

When [Create New Folder] is selected in the 1 menu, a folder is created with a new number when the next image is saved.

⚠ Caution

- You cannot successively create multiple folders.

🌀 Memo

- A new folder is automatically created in the following cases.
 - When [Drive Mode] is set to [Interval Shooting] in the 3 menu (p.72)
 - When [Save Interim Images] is set to [Unblended] or [Blended] in [Interval Composite] of [Drive Mode] in the 3 menu (p.73)
 - When [RAW Development] of the 4 menu is executed from the multi-image display screen, folder display screen, or shooting date display screen (p.89)

Folder Name

When images are captured with this camera, a folder is automatically created and the captured images are stored in it. Each folder name consists of a sequential number from 100 to 999 and a string of five characters.

The character string in the folder name can be changed.

1 Select [Folder Name] in the 1 menu and press .

The [Folder Name] screen appears.

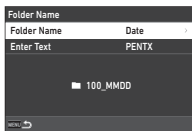

2 Select [Date] or [Optional] for [Folder Name] and press .

| | |
|-----------------|---|
| Date | <p>The four digits of the month and day of the shooting date are assigned after the folder number.</p> <p>The month and day appear according to the date format set in [Date Adjustment] of the 7 menu.</p> <p>Example) 101_0125: The folder for images captured on January 25th</p> |
| Optional | <p>A freely defined string of five characters is assigned after the folder number.</p> <p>(Default setting: PENTX)</p> <p>Example) 101PENTX</p> |

The screen of Step 1 reappears.

When you select [Date] or do not need to change the character string, proceed to Step 6.

3 Press to select [Enter Text], and press .

The text-entry screen appears.

4 Change the text.

Enter five single-byte alphanumeric characters.



Available operations

- Moves the cursor.
- Switches between alphabetical and numeric characters.
- Enters a character at the position of the cursor.

5 After entering the text, press .

The screen of Step 1 reappears.

6 Press twice.

- Memo**
 - A folder with a new number is created when the folder name is changed.
- Caution**
 - The maximum folder number is 999. After the folder number reaches 999, you cannot capture new images if you attempt to change the folder name or create a new folder, or when the file name number reaches 9999. In this case, perform [Reset Numbering] in the 1 menu.

File Name

One of the following string of characters is used as the file name prefix depending on the [Color Space] setting in the  menu.

| Color Space | File Name |
|-------------|--------------|
| sRGB | IMGP****.JPG |
| AdobeRGB | _IMG****.JPG |

The first four characters can be changed to a character string of your choice.

1 Select [File Name] in the  1 menu and press .
The [File Name] screen appears.

2 Select [Still Image] or [Movie], and press .
The text-entry screen appears.

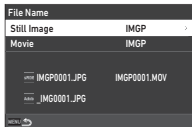

3 Change the text.
Up to four single-byte alphanumeric characters can be entered as an alternative for the first part of the file name, while the asterisks stand for figures that increase automatically shot by shot.

 Text entry (p.108)

4 Press  twice.

Memo

- When [Color Space] is set to [AdobeRGB], the file name prefix is “_” and first three characters of the entered character string becomes the file name.
- For movies, regardless of the [Color Space] setting, the file name is “IMGP****.MOV” or the one with the entered string of characters.

Sequential Numbering

In [Sequential Numbering] of the  1 menu, you can set whether to continue the sequential numbering for folder and file names even when a new folder is created or when memory cards are replaced.

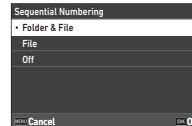

The serial number is continued or reset at the following timings depending on the [Sequential Numbering] setting.

| Sequential Numbering | When a new folder is created | When memory cards are replaced | |
|----------------------|------------------------------|--------------------------------|----------|
| | File No. | Folder Name | File No. |
| Folder & File | Continue | Continue | Continue |
| File | Continue | Reset | Continue |
| Off | Reset | Reset | Reset |

Reset Numbering

When a new image is taken after [Reset Numbering] of the  1 menu is performed, a folder with a new folder number is created and the file number starts from 0001.

Memo

- When the file number reaches 9999, a new folder is created and the file number is reset.

You can set the photographer and copyright information embedded in the Exif data.

1 Select [Copyright Information] in the 1 menu and press **▶**.

The [Copyright Information] screen appears.

2 Select [Embed Copyright Data] and press **▶**, select [On] or [Off], and press **OK**.

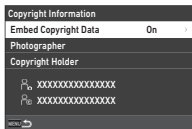

3 Select [Photographer] or [Copyright Holder], and press **▶**.

The text-entry screen appears.

4 Change the text.

Up to 32 single-byte alphanumeric characters and symbols can be entered.

 Text entry (p.96)

5 Press **MENU** twice.

Memo

- The Exif information can be checked in the “detailed information display” in the playback mode (p.15) or using the provided software “Digital Camera Utility 5”.

Restrictions on the Combinations of Special Functions

#: Restricted X: Not available

| | | AA Filter Simulator | HDR Capture | ASTRO-TRACER | Digital Filter/Clarity | Distortion Correction/Diffraction Correction | Save RAW Data |
|---------------------|-------------------------|---------------------|-------------|-----------------|------------------------|--|-----------------|
| Drive Mode | Continuous Shooting | # ^{*1} | X | X | | | X |
| | Bracketing | # ^{*1} | X | X | | | # ^{*3} |
| | Mirror Lock-up Shooting | # ^{*1} | X | | | | |
| | Multi-exposure | # ^{*1} | X | X | X | X | |
| | Interval Shooting | # ^{*1} | | # ^{*2} | | | # ^{*3} |
| | Interval Composite | # ^{*1} | X | X | X | X | # ^{*3} |
| AA Filter Simulator | | | X | # ^{*1} | | | # ^{*3} |
| HDR Capture | | X | | X | X | | |

*1 [Bracketing] is not available.

*2 [Type 1] and [Type 2] are available only when the timed exposure is enabled.

*3 Only the final frame can be saved.

Functions Available with Various Lenses

All capture modes are available when a D FA, DA, DA L, FA, or FA J lens is used, or when a lens with an **A** position is used with the aperture ring set to the **A** position.

When other lenses than above are used, or a lens with an **A** position is used in a position other than **A**, the following restrictions apply.

✓ : Available # : Restricted ✗ : Not available

| Function | Lens [Mount type] | | | | | |
|--|-------------------------------------|--------------------------|-----------------|-----------------|------------------|--|
| | D FA DA DA L | FA ^{*6} FA J | F ^{*6} | A | M P | |
| | [KAF] [KAF2] [KAF3] [KAF4] | [KAF] [KAF2] | [KAF] | [KA] | [K] | |
| Autofocus (Lens only) (With AF adapter 1.7×) ^{*1} | ✓ — | ✓ — | ✓ — | — # | — # | |
| Manual focus (With focus indicator) ^{*2} (With matte field) | ✓ | ✓ | ✓ | ✓ | ✓ | |
| Quick-shift focus | # ^{*4} | ✗ | ✗ | ✗ | ✗ | |
| AF Active Area [Auto Area] | ✓ | ✓ | ✓ | ✗ ^{*9} | ✗ ^{*9} | |
| AE Metering [Multi-segment] | ✓ | ✓ | ✓ | ✓ | ✗ | |
| P/Sv/Tv/Av/TA v mode | ✓ | ✓ | ✓ | ✓ | # ^{*10} | |
| M mode | ✓ | ✓ | ✓ | ✓ | # | |
| P-TTL auto flash ^{*3} | ✓ | ✓ | ✓ | ✓ | ✗ | |
| Power zoom | — | # ^{*7} | — | — | — | |
| Automatic obtaining of the lens focal length information | ✓ | ✓ | ✓ | ✗ | ✗ | |
| Lens Correction | # ^{*5} | # ^{*8} | ✗ | ✗ | ✗ | |

- *1 Lenses with a maximum aperture of F2.8 or faster. Only available at the **A** position.
- *2 Lenses with a maximum aperture of F5.6 or faster.
- *3 Available when using AF540FGZ, AF540FGZ II, AF360FGZ, AF360FGZ II, AF201FG, AF200FG, or AF160FC.
- *4 Only available with compatible lenses.
- *5 [Distortion Correction] and [Peripheral Illumin. Corr.] are disabled when a DA FISH-EYE 10-17mm lens is used.
- *6 To use an FA SOFT 28mm F2.8 lens, FA SOFT 85mm F2.8 lens, or F SOFT 85mm F2.8 lens, set [Using Aperture Ring] to [On] in the **C6** menu. Images can be taken with the aperture you set, but only within a manually adjustable aperture range.
- *7 The auto zoom and preset zoom are disabled.
- *8 The Lens Correction is available with the following FA lenses (only [Distortion Correction] can be used when the aperture ring is set to a position other than **A**.):
FA★24mm F2 AL [IF], FA 28mm F2.8 AL, FA 31mm F1.8 Limited, FA 35mm F2 AL, FA 43mm F1.9 Limited, FA 50mm F1.4, FA 77mm F1.8 Limited, FA★85mm F1.4 [IF], FA★200mm F2.8 ED [IF], FA★MACRO 200mm F4 ED, FA★300mm F2.8 ED [IF], FA★300mm F4.5 ED [IF], FA★400mm F5.6 ED [IF], FA★600mm F4 ED [IF], FA★28-70mm F2.8 ED [IF], FA★80-200mm F2.8 ED [IF], and FA★250-600mm F5.6 ED [IF].
- *9 Fixed to [Spot].
- *10 **Av** with the aperture set to wide open. (The aperture ring has no effect on the actual aperture value.)

⚠ Caution

- When the aperture ring is set to a position other than **A** or a lens without an **A** position or accessories such as an extension tube are used, the camera does not operate unless [Using Aperture Ring] is set to [On] in the **C6** menu. Refer to "Using the Aperture Ring" (p.114), for details.
- When a retractable lens is attached and is not extended, you cannot take images or use some functions. If the lens is retracted during shooting, the camera stops working.

Lens Names and Mount Names

| | Mount | Lens Name | Lens Type |
|----|--------------|-----------|---|
| MF | S | S | For 35mm full-frame size |
| | K | P, M | |
| | KA | A | |
| AF | KAF | D FA | For 35mm full-frame size |
| | | DA | For APS-C size Without the aperture ring |
| | | FA | For 35mm full-frame size Power zoom not compatible |
| | | FA J | For 35mm full-frame size Without the aperture ring |
| | | F | For 35mm full-frame size |
| | KAF2 | DA | For APS-C size Compatible with the built-in motor Without the aperture ring |
| | | FA | For 35mm full-frame size Power zoom compatible |
| | KAF3 KAF4 | D FA | For 35mm full-frame size Dedicated for the built-in motor Without the aperture ring |
| | | DA | For APS-C size Dedicated for the built-in motor Without the aperture ring |

- DA lenses with a motor and FA zoom lenses with a power zoom use the KAF2 mount. (Of these lenses, the lenses without an AF coupler use the KAF3 mount.)
- The KAF3 mount equipped with an electromagnetic diaphragm mechanism instead of an aperture control lever is referred to as the KAF4 mount.
- FA single focal length lenses, DA and DA L lenses without a motor, and D FA, FA J, and F lenses use the KAF mount. Refer to respective lens manuals for details.

Restrictions on the Selection of AF Points

When the following lenses are used, the AF points on both sides cannot be used while shooting with the viewfinder.

See RICOH IMAGING website for the latest information.

AF points for type A lenses

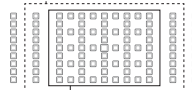

AF points for type B lenses

(As of October 2020)

| Type | Lens |
|---|---|
| A | smc PENTAX-F 35-70mm F3.5-4.5 |
| | smc PENTAX-F 35-80mm F4-5.6 |
| | smc PENTAX-FA 28mm F2.8 AL |
| | smc PENTAX-FA 28mm F2.8 soft |
| | smc PENTAX-FA 35-80mm F4-5.6 |
| | smc PENTAX-FAJ 18-35mm F4-5.6 |
| | smc PENTAX-FAJ 28-80mm F3.5-5.6 |
| | smc PENTAX-DA FISH-EYE10-17mm F3.5-4.5 ED[IF] |
| | HD PENTAX-DA FISH-EYE10-17mm F3.5-4.5 ED |
| | smc PENTAX-DA 50-200mm F4-5.6 ED |
| | smc PENTAX-DA 50-200mm F4-5.6 ED WR |
| | smc PENTAX-DAL 50-200mm F4-5.6 ED |
| | smc PENTAX-DAL 50-200mm F4-5.6 ED WR |
| smc PENTAX-DA 18-250mm F3.5-6.3 ED AL[IF] | |
| B | smc PENTAX-DA 15mm F4 ED AL Limited |
| | HD PENTAX-DA 15mm F4 ED AL Limited |
| | smc PENTAX-DA 21mm F3.2 AL Limited |
| | HD PENTAX-DA 21mm F3.2 AL Limited |
| | HD PENTAX-DA 560mm F5.6 ED AW |

The shutter can be released even if the aperture ring of the D FA, FA, F, or A lens is not set to the **A** position or a lens without an **A** position is attached.

Set [Using Aperture Ring] to [On] in the **C6** menu.

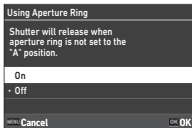

With the automatic exposure control, the camera operates as follows.

| Mode Dial | Camera Operation |
|------------------|--|
| P, Sv, Av | Av mode |
| Tv | When the ISO sensitivity is set to ISO Auto: TA v mode When the ISO sensitivity is set to a fixed value: M mode |
| TA v | TA v mode |
| M | M mode |
| B | B mode |
| X | X mode |

● Memo

- [F--] appears for the aperture indicator on the status screen, etc. When [Aperture Info Record] is set to [On] in the **C6** menu, the aperture value set with , , and is displayed, and only "F" blinks.
- Set [Aperture Info Record] to [On] in the **C6** menu to record the aperture value set for recording with , , and in captured images.

● Caution

- When shooting using the automatic exposure control, note the following points.
 - Images can be taken with the set aperture value but an exposure deviation may occur.
 - When shooting with the optical viewfinder, you cannot check the shutter speed and ISO sensitivity before shooting because the metering is performed immediately before the shutter is released. When shooting with Live View, you can check the shutter speed and ISO sensitivity before shooting because the aperture is always narrowed down.
 - When a lens with automatic diaphragm is attached, the aperture is narrowed down immediately before the shutter is released, causing a time lag in the shutter release.

How to Achieve the Correct Exposure with the Aperture Ring Not Set to **A**

The correct exposure can be achieved by the following procedures when the aperture ring is not set to **A**.

- 1 Set the mode dial to **M**.
- 2 Set the aperture ring to the desired aperture.
- 3 Press .
The correct shutter speed will be set.
- 4 If the correct exposure cannot be achieved, adjust the ISO sensitivity.

Setting the Focal Length

C6

The Shake Reduction function operates by obtaining the lens information such as focal length. Set the focal length when using a lens that the focal length information cannot be automatically obtained.

1 Set [Using Aperture Ring] to [On] in the C6 menu.

2 Turn the camera off.

3 Attach a lens to the camera and turn the camera on.

The [MF Lens Focal Length] screen appears.

4 Use ▲▼◀▶ to set the focal length.

The focal length can also be selected from the input history by pressing **INFO**.

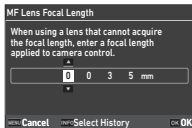

5 Press **OK**.

Memo

- The focal length setting can be changed in [MF Lens Focal Length] of the C6 menu.
- When a zoom lens is used, set the actual focal length which the zoom is set to.
- To not input the focal length at the camera startup when a lens that cannot automatically obtain the focal length information is attached to the camera, set [Length Input on Startup] to [Off] in the C6 menu.
- To record the focal length information you input in the image when a lens that cannot automatically obtain the focal length information is attached, set [Using Aperture Ring] to [On] in the C6 menu.

Functions when Using an External Flash

Use of the following external flashes (optional) enables a variety of flash modes, such as P-TTL auto flash mode.

✓: Available #: Restricted ✕: Not available

| Camera Function | Compatible Flash | AF540FGZ AF540FGZ II AF360FGZ AF360FGZ II | AF201FG AF200FG AF160FC |
|---|------------------|--|-------------------------------|
| Red-eye reduction flash | | ✓ | ✓ |
| Auto Flash Discharge *1 | | #*2 | #*2 |
| Automatic switch to the flash sync speed | | ✓ | ✓ |
| Automatic setting of the aperture value in P or Tv mode | | #*2 | #*2 |
| P-TTL auto flash | | #*2 | #*2 |
| Slow-speed Sync flash | | ✓ | ✓ |
| Flash Exposure Compensation | | ✓ | ✓ |
| AF assist light of the external flash | | #*3 | ✕ |
| Trailing Curtain Sync flash *4 | | ✓ | #*5 |
| Contrast Control Sync flash | | #*6 | #*7 |
| Slave flash | | #*6 | ✕ |
| High-speed Sync flash | | ✓ | ✕ |
| Wireless flash | | #*6 | ✕ |

- *1 Only the **AUTO** mode is available for the capture mode.
- *2 Available only when using a D FA, DA, DA L, FA, FA J, F, or A lens. (When using a lens with an aperture ring, set the aperture ring to the **A** position.)
- *3 AF assist light is not available with the AF540FGZ or AF360FGZ.
- *4 Shutter speed of 1/100 seconds or slower.
- *5 Not available with the AF200FG or AF160FC.
- *6 Multiple AF540FGZ, AF540FGZ II, AF360FGZ, or AF360FGZ II units are required.
- *7 Available only when combined with the AF540FGZ, AF540FGZ II, AF360FGZ, or AF360FGZ II.

Caution

- Flashes with the reversed polarity (the center contact on the hot shoe is minus) cannot be used due to the risk of damaging the camera and flash.
- Do not combine with accessories that have a different number of contacts, such as Hot Shoe Grip, as a malfunction may occur.
- Combining with flashes from other manufacturers may cause equipment breakdown.

Memo

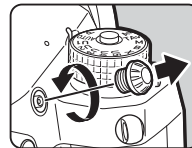

- With the AF540FGZ, AF540FGZ II, AF360FGZ, or AF360FGZ II, you can use the high-speed sync flash to discharge a flash and take an image at a shutter speed faster than 1/200 seconds. Set the exposure mode to **Tv**, **TAv**, or **M**.
- By using two or more external flashes (AF540FGZ, AF540FGZ II, AF360FGZ, or AF360FGZ II), you can use the wireless mode to shoot in the P-TTL flash mode without connecting the flash units with a cord. In this case, set the camera channel on the external flashes.
- You can set the flash sync speed in [X Mode Sync Speed] of the **C5** menu.
- You can connect an external flash to the camera with a sync cord by using the X-sync socket. Remove the sync socket 2P cap to connect a sync cord to the X-sync socket.



Using the GPS Unit

When the optional GPS Unit O-GPS1 or O-GPS2 is attached to the camera, GPS information is saved in the shooting information of an image, and furthermore, the “ASTROTRACER” function can be used.

You can check the GPS positioning status on the status screen and Live View screen.

| | |
|---|----------------|
|  | 3D positioning |
|  | 2D positioning |
|  | No positioning |



When an image is taken while the GPS is on, the GPS information is saved internally in the image file. The GPS information is not saved in the movie file. You can check the GPS information in “Detailed Information Display” in the playback mode. (p.15)

⚠ Caution

- “Electronic Compass”, “Simple Navigation”, and “GPS Time Sync” cannot be used with this camera.

📝 Memo

- Refer to the manual of the GPS unit for details on how to attach the unit and information on the unit’s functions.
- Perform a calibration with the GPS unit before shooting using [Calibration] in [GPS Settings] of the  menu to obtain the GPS information correctly.



Shooting Celestial Bodies (ASTROTRACER)

By matching the movement of the Shake Reduction unit built in the camera with the movement of celestial bodies, celestial bodies can be captured as individual points even when shooting with a long exposure setting.

When tracking and capturing celestial bodies without using the GPS unit (Type 3), refer to “Shooting without the GPS Unit” (p.119).

Setting the ASTROTRACER



- 1 Attach the GPS unit to the camera and turn the camera on.
- 2 Select [ASTROTRACER] in the  menu and press . The [ASTROTRACER] screen appears.
- 3 Select [ASTROTRACER] and press .
- 4 Select a type and press **OK**.

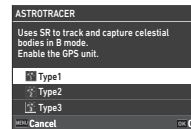

| | |
|---------------|--|
| Type 1 | Tracks and captures celestial bodies in B mode using the Shake Reduction function. |
| Type 2 | Tracks and captures celestial bodies with settings suitable for starscape photography in B mode using the Shake Reduction function. |
| Type 3 | Tracks and captures celestial bodies in B mode using the Shake Reduction function based on a test exposure. The GPS unit is not used. (p.119) |

- 5 Select **[Precise Calibration]** and press **▶**.
The [Precise Calibration] screen appears.
 - 6 Rotate the camera according to the instruction displayed on the monitor.
The result of calibration appears.
 - 7 Press **OK**.
The screen of Step 4 reappears.
If [Calibration failed. Perform calibration again.] appears, change the camera direction and perform a calibration again.
 - 8 Press **MENU** twice.
The camera returns to the standby mode.
- ⚠ Caution**
- When performing a calibration, be careful not to drop the camera. Wrap the strap around your wrist or take other preventive measures.
 - If the battery is removed, perform a calibration again after the battery is put back in.
 - As the magnetic field environment varies depending on the shooting location, [Precise Calibration] must be performed at each location.
 - Changing the lens after performing a calibration may have some effect on the magnetic field environment. In this case, perform a calibration again.

When the Monitor Is Too Bright

When shooting in a dark place for a long period of time, change the [Outdoor View Setting] setting in the 2 menu to reduce glare.





Also, you can prevent eyes dazzling in dark places by setting [Night Vision Display] to [On] in the 2 menu.

Shooting with the GPS Unit

- 1 Set the exposure mode to **B**.
The ASTROTRACER is ready for use.
- 2 Set the shooting conditions.



Available operations

- | | |
|---|--|
|  | Enables/Disables the timed exposure. |
|  | Changes the exposure time within the range from 0'01" to 5'00" when the timed exposure is enabled. |
|  | Changes the aperture value. |
|  | Performs a precise calibration. |

- 3 Adjust the focus and press **SHUTTER**.
When the timed exposure is enabled, shooting stops automatically after the set time has elapsed.
When the timed exposure is not set, the exposure continues while **SHUTTER** is pressed.

- ⚠ Caution**
- This function cannot be used in combination with some other functions. (p.111)
 - Shooting cannot be performed when the GPS information has not been obtained by the GPS unit.

Shooting without the GPS Unit



You can capture celestial bodies only with the camera without using the GPS unit.

Preliminary shooting is automatically performed before actual shooting to calculate the movement amount of exposed celestial bodies. Based on the calculation results, celestial bodies are tracked and captured.

- 1 Set the camera on a fixed tripod.**
- 2 Set [ASTROTRACER] to [Type 3] in the  menu.**
- 3 Set the exposure mode to **B**.**
The timed exposure is enabled.
- 4 Set the shooting conditions.**



Available operations

| | |
|---|--|
|  | Sets the ISO sensitivity. |
|  | Changes the exposure time within the range from 0'01" to 10'00". |
|  | Changes the aperture value. |

- 5 Focus on the celestial bodies and set the composition.**
- 6 Shoot while being careful not to blur the image.**
After preliminary shooting, main shooting starts.
The exposure ends at the set time.

Memo

- When using a lens with a longer focal length, the composition may change during preliminary shooting. Shift the composition for the expected change beforehand or allow room for the composition.
- To prevent blurring, it is recommended to use the optional cable release or remote control unit.
- When [Interval Shooting] is set in [Drive Mode] of the  3 menu, you can perform main shooting multiple times after preliminary shooting.
- The exposure time can be specified up to 10 minutes. If you set the exposure time to 1 minute or less, celestial bodies can be relatively stably captured as dots.

Caution

- The bulb exposure cannot be used.
- In the following cases, preliminary shooting may fail or the image may be blurred due to incorrect tracking of celestial bodies.
 - When objects other than celestial bodies such as landscapes or clouds are captured
 - When the celestial bodies are not captured sufficiently due to light pollution, etc.
 - When celestial bodies are not in focus
 - When the camera is unstable, causing blurring
- Fish-eye lenses cannot be used.
- Zoom lenses can only be used at the wide end or tele end. The following lenses can be used with all areas.
 - HD PENTAX-DA 55-300mm F4.5-6.3 ED PLM WR RE
 - HD PENTAX-DA * 11-18mm F2.8 ED DC AW
 - HD PENTAX-DA * 16-50mm F2.8 ED PLM AW

Troubleshooting



Memo

- In rare cases, the camera may not operate correctly due to causes such as static electricity, etc. This can be remedied by taking the battery out and putting it back in again. If the camera operates correctly, it does not require any repairs.

| Problem | Cause | Remedy |
|---------------------------------|---|--|
| The camera does not turn on. | The battery is not installed properly. | Check the orientation of the battery. |
| | The battery power is low. | Charge the battery. |
| The shutter cannot be released. | There is no available space on the memory card. | Insert a memory card with available space or delete unwanted images. |
| | Data is being processed. | Wait until processing is finished. |
| | The lens aperture ring is set to a position other than A . | Set the lens aperture ring to the A position or set [Using Aperture Ring] to [On] in the C6 menu. (p.114) |
| | [AF Mode] is set to [Single AF] and the subject is not in focus. | Set the focus method to MF and adjust focus manually. |
| Autofocus does not work. | The subject is difficult to focus on. | AF cannot work well for low-contrast objects (the sky, white walls, etc.), dark colors, intricate designs, rapidly-moving objects, or scenery shot through a window or a net-like pattern. Lock focus on another object located at the same distance as your subject, then aim at the subject and take an image. Alternatively, use MF . |
| | The subject is too close. | Move away from the subject and take an image. |

| Problem | Cause | Remedy |
|---|--|---|
| The flash does not discharge. | [Flash Mode] is set to [Auto Flash Discharge]. | When [Flash Mode] is set to [Auto Flash Discharge] in the C2 menu, the flash does not discharge if the subject is bright. Change the [Flash Mode] setting. (p.75) |
| The memory card is not recognized when the camera is connected to a computer. | The [USB Setting] is set to [CD-ROM]. | Set [USB Setting] to [MTP] in the 4 menu. (p.93) |
| Dust or dirt particles appear in images. | The CMOS sensor is dirty or dusty. | Activate [Dust Removal] from the 6 menu. The Dust Removal function can be activated every time the camera is turned on and off. Refer to "Sensor Cleaning" (p.121) if the problem persists. |
| Pixel defects such as bright spots and dark spots appear in the image. | There are defective pixels in the CMOS sensor. | Activate [Pixel Mapping] from the 6 menu. It takes about 30 seconds to correct the defective pixels, so be sure to install a fully charged battery. |

Raise the mirror up and open the shutter when cleaning the CMOS sensor with a blower.

- 1 Turn the camera off and remove the lens.**
- 2 Turn the camera on.**
- 3 Select [Sensor Cleaning] in the  6 menu and press .**
The confirmation screen appears.
- 4 Select [Execute] and press .**
The mirror rises up.
- 5 Clean the CMOS sensor with a blower.**
- 6 Turn the camera off.**
The mirror automatically returns to its original position.



Caution

- Never use a spray blower or a blower with a brush. The CMOS sensor may be damaged. Do not wipe the CMOS sensor with a cloth.
- Do not put the tip of the blower inside the lens mount area. If the power is turned off during cleaning, it may cause damage to the shutter, the CMOS sensor, and the mirror. Hold the camera with the lens mount down while cleaning the sensor so dust will fall away from the sensor when the blower is used.
- When the battery level is low, the message [Not enough battery power remaining to clean sensor.] is displayed on the monitor. Install a fully charged battery. If the battery capacity becomes low during cleaning, a warning beep will sound. In this case, stop cleaning immediately.

Memo

- Please contact your nearest service center for professional cleaning as the CMOS sensor is a precision part.
- You can use the optional Image Sensor Cleaning Kit O-ICK1 when cleaning the CMOS sensor.

Error Messages

| Error Message | Description |
|---|---|
| Memory card full. | The memory card is full and no more images can be saved. Insert a new memory card or delete unwanted files. |
| No image. | There are no images that can be played back on the memory card. |
| This image cannot be displayed. | You are trying to play back an image in a format not supported by this camera. You may be able to play it back on a computer. |
| No card in the camera. | There is no memory card inserted in the camera. |
| Memory card error. | The memory card has a problem, and image capture and playback are impossible. You may be able to play back or recover the images on a computer. |
| Card is not formatted. | The memory card you have inserted is unformatted or has been previously used on another device and is not compatible with this camera. Use the card after formatting it with this camera. |
| Card is locked. | The write-protect switch on the memory card you have inserted is locked. (p.132) |
| This card cannot be used. | A memory card not compatible with this camera is inserted. |
| This image cannot be magnified. | You are trying to magnify an image that cannot be magnified. |
| Not enough battery power remaining to activate Pixel Mapping. | The battery level is too low to perform [Pixel Mapping] or [Sensor Cleaning] of the  6 menu, or to update the firmware. Install a fully charged battery. |
| Not enough battery power remaining to clean sensor. | |
| Not enough battery power remaining to update the firmware. | |
| Not enough battery power remaining to provide USB power supply. | The battery level is too low to perform [USB Power Supply to Ext.] of the  5 menu. Install a fully charged battery. |
| Unable to update firmware. There is a problem with the firmware update file. | The firmware cannot be updated. The update file is damaged. Try downloading the update file again. |

| Error Message | Description |
|--|---|
| Image folder cannot be created. | The maximum folder number (999) is being used, and no more images can be saved. Insert a new memory card or format the card. |
| Unable to store image. | The image could not be saved because of a memory card error. |
| Data process failed. | The operation failed. Try the operation again. |
| No image can be processed. | There are no images with which RAW images can be developed. |
| This image cannot be processed. | You are trying to perform  menu functions for the images captured using other cameras or perform [Resize] or [Cropping] for the minimum file-size images, or the maximum number of digital filters that can be applied to an image is reached. |
| This function cannot process multiple images as a batch. | You are trying to perform a playback function that cannot be performed for multiple images on the folder display screen or shooting date display screen. |
| This function is not available in the current mode. | You are trying to set a function that is not available with the currently selected capture mode. |
| The camera will turn off to prevent damage from overheating. | The camera will turn off because its internal temperature is too high. Leave the camera turned off until it has had time to cool down before turning on the camera again. |
| Turn the lens zoom ring to the position where shooting is possible. | Images cannot be taken when a retractable lens is attached and is not extended. (p.45) |

Main Specifications

Camera

Model Description

| | |
|-------------------|--|
| Type | TTL autofocus, auto-exposure SLR digital camera |
| Lens Mount | PENTAX KAF2 bayonet mount (AF coupler, lens information contacts, K-mount with power contacts) |
| Compatible Lenses | KAF4, KAF3, KAF2 (power zoom compatible), KAF, KA mount lenses |

Image Capture Unit

| | |
|-------------------------------|---|
| Image Sensor | Monochrome, CMOS, Size: 23.3 × 15.5 (mm) |
| Effective Pixels | Approx. 25.73 megapixels |
| Total Pixels | Approx. 26.78 megapixels |
| Dust Removal | Image sensor cleaning using ultrasonic vibrations "DR II" |
| Sensitivity (Standard Output) | ISO Auto, Manual ISO range: 200 to 1600000 • EV steps can be set to 1 EV, 1/2 EV, or 1/3 EV. |
| Image Stabilizer | Sensor-shift Shake Reduction "SR II" (5-axis image stabilization system), Setting: Auto, Panning, Off |
| AA Filter Simulator | Moiré reduction using the SR unit: Off, Low, High, Bracketing (2 images), Bracketing (3 images) |

File Formats

| | | | | | | | | | |
|--------------------------|---|--------------------------|--------------------|--------------------------|--------------------|--------------------------|-------------------|--------------------------|-------------------|
| Recording Formats | RAW (PEF/DNG), JPEG (Exif 2.3 compliant), DCF 2.0 compliant | | | | | | | | |
| Recorded Pixels | JPEG: <table border="0"> <tr><td><input type="checkbox"/></td><td>(26M: 6192 × 4128)</td></tr> <tr><td><input type="checkbox"/></td><td>(15M: 4752 × 3168)</td></tr> <tr><td><input type="checkbox"/></td><td>(9M: 3648 × 2432)</td></tr> <tr><td><input type="checkbox"/></td><td>(2M: 1920 × 1280)</td></tr> </table> RAW: (26M: 6192 × 4128) | <input type="checkbox"/> | (26M: 6192 × 4128) | <input type="checkbox"/> | (15M: 4752 × 3168) | <input type="checkbox"/> | (9M: 3648 × 2432) | <input type="checkbox"/> | (2M: 1920 × 1280) |
| <input type="checkbox"/> | (26M: 6192 × 4128) | | | | | | | | |
| <input type="checkbox"/> | (15M: 4752 × 3168) | | | | | | | | |
| <input type="checkbox"/> | (9M: 3648 × 2432) | | | | | | | | |
| <input type="checkbox"/> | (2M: 1920 × 1280) | | | | | | | | |
| Quality Level | RAW (14bit): PEF, DNG JPEG: ★★★ (Super Fine), ★★ (Fine), ★ (Economy) • RAW + JPEG simultaneously recordable | | | | | | | | |
| Color Space | sRGB, AdobeRGB | | | | | | | | |
| Storage Media | SD/SDHC*/SDXC* memory cards * UHS-I/UHS-II compatible (UHS-II is only available for the memory card inserted in the SD1 slot.) | | | | | | | | |

| | |
|-----------------|---|
| Dual Card Slots | Sequential Use, Save to Both, Separate RAW/JPEG, Copying images between slots possible |
| Storage Folder | Folder Name: Date (100_1018_101_1019...) or a user-assigned name (default: PENTX) |
| Storage File | File Name: User-assigned name (default: IMGPF****) File No.: Sequential Numbering, Reset |

Viewfinder

| | |
|--------------------|---|
| Type | Pentaprism finder |
| Coverage (FOV) | Approx. 100% |
| Magnification | Approx. 1.05× (FA 50mm F1.4 at infinity) |
| Eye-Relief Length | Approx. 20.5 mm (from the view window) Approx. 22.0 mm (from the center of lens) |
| Diopter Adjustment | Approx. -4 to +1 m ⁻¹ |
| Focusing Screen | Natural-Bright-Matte III focusing screen |
| Overlay Items | AF points, Grid display, Electronic level, AF frame, Spot metering frame, Frame for cropping, Smart Function icons, Operation Control Lock icon |

Live View

| | |
|-----------------|---|
| Type | TTL method using the CMOS image sensor |
| Focusing System | Contrast detection (Auto Area, Zone Select, Tracking, Select (L, M, S), Spot) |
| Function | Focus Peaking, Face Detection, Touch AF |
| Display | Field of view: approx. 100%, Magnified view (up to 16×), Grid Display (4×4 Grid, Golden Section, Scale, Square (L), Square (S), Grid Color: Black, Gray, White), Histogram, Highlight Alert, Composition Adjustment |

LCD Monitor

| | |
|----------------------|--|
| Type | Wide viewing angle TFT color LCD with air-gapless tempered glass |
| Size | 3.2 inches (aspect ratio 3:2) |
| Dots | Approx. 1620K dots |
| Touch Panel | Capacitance type |
| Adjustment | Brightness (Auto, Manual), saturation, and colors adjustable |
| Outdoor View Setting | Adjustable ±2 steps |
| Night Vision Display | On, Off |

Focus System

| | |
|-------------------------------|---|
| Type | TTL phase-matching detection autofocus |
| Focus Sensor | SAFOX13, 101 points (25 cross type focus points in the center) |
| Brightness Range | EV -3 to 19 (ISO 200, at normal temperature) • -3 EV is only available for AF points that support F2.8 light flux when an F2.8-light-flux compatible lens is attached. |
| AF Modes | Single AF (AF.S), Continuous AF (AF.C) |
| Focusing Area Selection Modes | Auto Area, Zone Select, Select, Expanded Area AF (S, M, L), Select (S), Select (XS), Spot |
| AF Assist Light | Dedicated LED AF assist light |

Exposure Control

| | |
|-----------------|--|
| AE Metering | TTL open-aperture metering using 307K pixel RGB-Ir sensor Metering modes: Multi-segment, Center-weighted, Spot, Highlight-weighted |
| Metering Range | EV -2 to 21 (ISO 200 at 50mm F1.4) |
| Exposure Modes | Scene Analyze Auto, Program, Sensitivity Priority, Shutter Priority, Aperture Priority, Shutter & Aperture Priority, Manual, Bulb, Flash X-sync Speed, USER1, USER2, USER3, USER4, USER5 |
| EV Compensation | ±5 EV (1/3 EV steps or 1/2 EV steps can be selected) |
| AE Lock | Button type (timer-control: two times the meter operating time set in customization setting); continues as long as SHUTTER is halfway pressed. |

Shutter

| | |
|---------------|--|
| Type | Selectable between the electronically controlled vertical-run focal plane shutter and the electronic shutter |
| Shutter Speed | [Mechanical Shutter] Auto: 1/8000 to 30 seconds, Manual: 1/8000 to 30 seconds (1/3 EV steps or 1/2 EV steps), Bulb (timed exposure settable: 1 second to 20 minutes) [Electronic Shutter] Auto: 1/16000 to 30 seconds, Manual: 1/16000 to 30 seconds (1/3 EV steps or 1/2 EV steps) |

Drive Modes

| | |
|----------------------|--|
| Mode Selection | Single Frame Shooting, Continuous Shooting (H, M, L), Bracketing (2, 3, or 5 frames), Depth of Field Bracketing, Motion Bracketing, Mirror Lock-up Shooting, Multi-exposure (Average, Additive, Bright), Interval Shooting, Interval Composite |
| Timer/Remote Control | Self-timer (12 or 2 seconds), Remote Control (Now, 3 seconds) |
| Continuous Shooting | Max. approx. 12 fps, JPEG ([L]: ★★★ at Continuous Shooting (H)): Up to approx. 55 frames, RAW: Up to approx. 32 frames, RAW+: Up to approx. 30 frames Max. approx. 7.0 fps, JPEG ([L]: ★★★ at Continuous Shooting (M)): Up to approx. 100 frames, RAW: Up to approx. 40 frames, RAW+: Up to approx. 33 frames Max. approx. 2.5 fps, JPEG ([L]: ★★★ at Continuous Shooting (L)): Up to approx. 100 frames, RAW: Up to approx. 100 frames, RAW+: Up to approx. 65 frames • When the ISO sensitivity is set to ISO 200 • The continuous shooting speed is slower when shooting with a high ISO sensitivity. |

External Flash

| | |
|-----------------------------|---|
| Flash Modes | Auto Flash Discharge, Auto Flash + Red-eye Reduction, Flash On, Flash On + Red-eye Reduction, Slow-speed Sync, Slow-speed Sync + Red-eye Reduction, P-TTL, Contrast Control Sync*, High-speed Sync, Wireless Sync* * Available with two or more dedicated external flash units |
| Sync Speed | 1/200 seconds |
| Flash Exposure Compensation | -2.0 to +1.0 EV |

Capture Functions

| | |
|-----------------|--|
| Custom Image | Standard, Hard, Soft |
| Digital Filter | Toy Camera, Retro, High Contrast, Shading, Invert Color, Tone Expansion, Grainy Monochrome |
| Clarity | -4.0 to +4.0 |
| HDR Capture | Auto, Type1, Type2, Type3, Advanced HDR Bracket Value adjustable Auto Align: On, Off |
| Lens Correction | Distortion Correction, Peripheral Illumination Correction, Diffraction Correction |

| | |
|--------------------------|---|
| Dynamic Range Correction | Highlight Correction, Shadow Correction |
| Noise Reduction | Slow Shutter Speed Noise Reduction, High-ISO Noise Reduction |
| ASTROTRACER | Type 1, Type 2, Type 3 • Type 1 and Type 2 are available when using the O-GPS1/O-GPS2 (optional). |
| Horizon Correction | SR On: Corrects up to 1 degree SR Off: Corrects up to 2 degrees |
| Composition Adjustment | Adjustment range of ± 1.5 mm up, down, left or right (± 1 mm when rotated), Rotating range of ± 1 degree |
| Electronic Level | Viewfinder Display (horizontal direction and vertical direction), Monitor Display (horizontal direction and vertical direction) |
| Program Line | Auto, Standard, Hi-speed Priority, DOF Priority (Deep), DOF Priority (Shallow), MTF Priority |

Movie

| | |
|--------------------------------|---|
| Recording Format | MPEG-4 AVC/H.264 (MOV) |
| Recorded Pixels/ Frame Rate | 4K (3840 × 2160, 30p/24p) FHD (1920 × 1080, 60p/30p/24p) |
| Sound | Built-in stereo microphone, external microphone (stereo recording compatible) Recording Sound Level adjustable, Wind Noise Reduction |
| Recording Time | Up to 4 GB or 25 minutes Automatically stops recording if the internal temperature of the camera becomes high |
| Custom Image | Standard, Hard, Soft |
| Digital Filter | Retro, High Contrast, Invert Color |

Playback Functions

| | |
|---------------|--|
| Playback View | Single image, Multi-image display (20, 48, and 70 thumbnails), Image magnification (Up to 16×, 100% display, Quick Zoom, and Focus Magnification), Grid (4×4 Grid, Golden Section, Scale, Square (L), Square (S), Grid Color: Black, Gray, White), Rotated image display, Histogram display (Y histogram), Highlight Alert display, Auto image rotation, Detailed information display, Copyright Information display (Photographer, Copyright Holder), GPS information (Latitude, Longitude, Altitude, Coordinated Universal Time (UTC)), Direction, Folder display, Shooting date display |
|---------------|--|

| | |
|------------------|--|
| Delete | Single image, All images, Selected images, Folder, Images on the selected shooting date, Instant Review image |
| Digital Filter | Base Parameter Adj, Toy Camera, Retro, High Contrast, Shading, Invert Color, Tone Expansion, Grainy Monochrome, Miniature, Soft, Fish-eye, Slim, Frame Composite |
| RAW Development | Development options: Single image, Multiple images, Folder, Images on the selected shooting date Development parameters: Custom Image, Sensitivity, Digital Filter, Clarity, HDR Capture, Distortion Correction, Peripheral Illumination Correction, Diffraction Correction, High-ISO Noise Reduction, Shadow Correction, File Format (JPEG, TIFF), JPEG Recorded Pixels, JPEG Quality, Aspect Ratio, Color Space |
| Editing Features | Protect, Image Rotation, Image Copy, File Transfer, Save RAW Data, Resize, Cropping (aspect ratio can be changed and tilt correction is available), Levels Adjustment, Extract Movie, Divide Movie, Save Movie Frame as Image |

Customization

| | |
|--------------------|---|
| Customizable Items | User Mode, Fx Button, AF/AE Lock Settings, Preview Dial, E-Dial Programming, Smart Function, Touch Panel, Eye Sensor, Viewfinder Display, LCD Panel, Monitor Display, Instant Review, Zoom Review, Warning Display, Control Panel, Memory, EV Steps, ISO Sensitivity Steps, Focal Length Input, Save Rotation Information, Aperture Information Record, AF Fine Adjustment, Copyright Information |
| Language | 21 languages: Japanese, English, French, German, Spanish, Portuguese, Italian, Dutch, Danish, Swedish, Finnish, Polish, Czech, Hungarian, Turkish, Greek, Russian, Thai, Korean, Traditional Chinese, Simplified Chinese |

Power Supply

| | |
|--------------|---|
| Battery Type | Rechargeable Lithium-ion Battery D-LI90 |
| AC Adapter | AC Adapter Kit K-AC166 (optional) |
| Battery Life | Number of recordable images: Approx. 800 images Playback time: Approx. 250 minutes • Tested in compliance with CIPA standard using a fully charged lithium-ion battery at a temperature of 23°C (73°F). Actual results may vary depending on the shooting conditions/circumstances. |

Interfaces

| | |
|-----------------|--|
| Connection Port | USB terminal (USB Type-C), Cable release terminal (2.5 mm dia.), X-sync socket, HDMI® terminal (Type D), Microphone terminal, Headphone terminal |
| USB Connection | USB 3.2 Gen 1 Data transfer: MTP, CD-ROM Battery recharge, Power supply to the camera (when the dedicated AC adapter is used) |

Wireless LAN

| | |
|------------------------------|---|
| Standards | IEEE 802.11b/g/n (standard wireless LAN protocol) |
| Frequency (Center Frequency) | 2412 to 2462 MHz (channels: Ch 1 to Ch 11) |
| Security | Authentication: WPA2 Encryption: AES |

Bluetooth®

| | |
|------------------------------|--|
| Standards | Bluetooth® v4.2 (Bluetooth Low Energy) |
| Frequency (Center Frequency) | 2402 to 2480 MHz (channels: Ch 0 to Ch 39) |

Dimensions and Weight

| | |
|------------|--|
| Dimensions | Approx. 134.5 mm (W) × 103.5 mm (H) × 73.5 mm (D) (5.3 in. (W) × 4.1 in. (H) × 2.9 in. (D)) (excluding protrusions) |
| Weight | Approx. 820 g (28.9 oz) (including the dedicated battery and an SD Memory Card) Approx. 735 g (25.9 oz) (body only) |

Operating Environment

| | |
|-------------|-------------------------------|
| Temperature | -10 to 40°C (14 to 104°F) |
| Humidity | 85% or less (no condensation) |

Included Accessories

| | |
|------------------|---|
| Package Contents | Strap O-ST162, ME Viewfinder Cap, Rechargeable Lithium-ion Battery D-LI90, USB Power Adapter, Power Plug, USB Cable I-USB166 <Mounted to the camera> Eyecup Fu, Hot shoe cover Fk, Sync socket 2P cap, Body mount cap KII, Battery grip terminal cover |
| Software | Digital Camera Utility 5 |

USB Power Adapter

| | |
|---------------------------|---|
| Rated Input | 100 to 240 VAC (50/60 Hz), 0.2 A |
| Rated Output | 5.0 VDC, 1.0 A, 5.0 W |
| Average Active Efficiency | 76% |
| No-Load Power Consumption | 70 mW |
| Operating Temperature | 0 to 40°C (32 to 104°F) • It depends on the operating temperature of the camera. |
| Storage Temperature | -20 to 60°C (-4 to 140°F) |
| Dimensions | 42.5 mm × 22 mm × 66.5 mm (1.7 in. × 0.9 in. × 2.6 in.) (excluding the power plug) |
| Weight | Approx. 40 g (1.4 oz) (excluding the power plug) |

Rechargeable Lithium-ion Battery D-LI90

| | |
|-----------------------|---|
| Rated Voltage | 7.2 V |
| Rated Capacity | 1860 mAh (14 Wh) |
| Operating Temperature | -10 to 60°C (14 to 140°F) • It depends on the operating temperature of the camera. |
| Storage Temperature | -20 to 50°C (-4 to 122°F) |
| Dimensions | Approx. 39.5 mm × 56.8 mm × 21.1 mm (2.2 in. × 1.4 in. × 0.6 in.) |
| Weight | Approx. 85 g (3 oz) |

Optional Accessories

| | |
|--------------|--|
| GPS Unit | O-GPS1/O-GPS2: GPS information (Latitude, Longitude, Altitude, Coordinated Universal Time), Direction, ASTROTRACER |
| Cable Switch | CS-205 |

Approximate Image Storage Capacity and Playback Time

(When using the fully charged battery)

| Battery | Temperature | Normal Shooting | Playback Time |
|---------|-------------|-----------------|---------------|
| D-LI90 | 23°C (73°F) | 800 | 250 minutes |

- The image storage capacity (normal recording) is based on measuring conditions in accordance with CIPA standards, while other data is based on our measuring conditions. Some deviation from the above figures may occur in actual use depending on the selected capture mode and shooting conditions.

Approximate Image Storage Capacity by Size

(When using an 8 GB memory card)

| Recorded Pixels | JPEG Quality | | | RAW |
|-----------------|--------------|------|------|-----|
| | ★★★ | ★★ | ★ | |
| 26M | 411 | 704 | 1120 | 126 |
| 15M | 694 | 1185 | 1872 | — |
| 9M | 1168 | 1978 | 3105 | — |
| 2M | 4021 | 6630 | 9812 | — |

- The number of storable images may vary depending on the subject, shooting conditions, selected capture mode, memory card, etc.

Operating Environment for USB Connection and Provided Software

We recommend the following system requirements to connect the camera to a computer and to use the software.

Windows®

| | |
|----------------|--|
| OS | Windows® 11, Windows® 10 |
| CPU | Intel® Core™ i5 or higher |
| RAM | 8 GB or more |
| HDD | For installing and starting up the program: Approx. 100 MB or more of available space For saving image files: Approx. 15 MB/file (JPEG), Approx. 50 MB/file (RAW) |
| Monitor | 1280 × 1024 dots, 24-bit full color or higher |

Mac

| | |
|----------------|--|
| OS | macOS 13 Ventura, macOS 12 Monterey, macOS 11 Big Sur, macOS 10.15 Catalina |
| CPU | Intel® Core™ i5 or higher |
| RAM | 8 GB or more |
| HDD | For installing and starting up the program: Approx. 100 MB or more of available space For saving image files: Approx. 15 MB/file (JPEG), Approx. 50 MB/file (RAW) |
| Monitor | 1280 × 1024 dots, 24-bit full color or higher |

Memo

- Application software that supports the MOV format is required to play back movie files transferred to a computer.

Symbols

| | |
|------------------|----|
| menus | 22 |
| menus | 25 |
| menus | 26 |
| menus | 27 |
| menus | 33 |
| mode | 54 |
| / / dial | 43 |

Numerics

| | |
|--------------------------------|----|
| 1× image display | 46 |
| 1st Frame Action in AF.C | 61 |

A

| | |
|---|-----------|
| AC Adapter | 40 |
| Action in AF.C Continuous Shooting | 61 |
| Action When AF Fails | 62 |
| AdobeRGB | 47 |
| Advanced mode | 52 |
| AE Metering | 59 |
| AF Active Area (contrast detection autofocus) | 64 |
| AF Active Area (phase-matching detection autofocus) | 60 |
| AF Area Restriction | 61 |
| AF Assist Light | 9, 60, 65 |
| AF coupler | 9 |
| AF Fine Adjustment | 65 |
| AF Frame | 44, 45 |
| AF Mode | 60 |
| AF point | 61 |
| AF Point for H/V Comp. | 61 |
| AF point selector lever | 61 |

| | |
|--|-------------|
| AF Point Tracking in AF.C | 62 |
| AF with Live View | 63 |
| AF with Remote Control .. | 75 |
| AF with Viewfinder | 60 |
| AF.S Setting | 61 |
| AF/AE Lock Settings | 44, 59, 100 |
| Anti-Aliasing Filter Simulator | 80 |
| Aperture Priority AE | 49 |
| Aperture value | 49 |
| Aspect Ratio | 89, 91 |
| ASTROTRACER | 117 |
| Auto Area (contrast detection autofocus) | 63 |
| Auto Area (phase-matching detection autofocus) | 60 |
| Auto Display Rotation | 104 |
| Auto EV Compensation | 23, 50 |
| Auto Flash Discharge | 75 |
| Auto Horizon Correction .. | 81 |
| Auto Image Rotation | 82 |
| AUTO mode | 43 |
| Auto Power Off | 41 |
| Auto Shake Reduction Off | 80 |
| Autofocus | 59 |
| Av bracketing | 69 |
| AV device | 84 |
| Av mode | 49 |

B

| | |
|--|----|
| B mode | 52 |
| Base Parameter Adjustment (Digital Filter) | 88 |

| | |
|-----------------------------|--------|
| Battery | 37 |
| Battery grip | 38 |
| Battery grip contacts | 9 |
| Battery Grip Settings | 38, 39 |
| Bluetooth® | 95 |
| Bracketing | 68 |
| Bracketing Order | 68 |
| Brightness adjustment | 13, 78 |
| Bulb | 52 |
| Bulb (B) Mode Options | 52 |
| Bulb exposure | 49, 52 |
| Button | 10 |

C

| | |
|--------------------------------|---------|
| Cable switch terminal | 9 |
| Calibration | 117 |
| Capture mode | 48 |
| Card | 40 |
| Card access lamp | 9 |
| Card Slot Sequence | 47 |
| Catch-in Focus | 62 |
| CD-ROM | 93 |
| Center-weighted metering | 59 |
| Changing display | 14 |
| Changing the image size | 90 |
| Charging the battery | 38 |
| Charging time | 39 |
| Clarity | 80 |
| Cleaning | 121 |
| Color Settings | 42, 104 |
| Color Space | 47 |
| Composition Adjustment | 81 |

| | |
|---|-------------|
| Computer | 93 |
| Continuous AF | 60 |
| Continuous Shooting | 68 |
| Contrast Detection AF Release Options | 64 |
| Contrast detection autofocus | 59, 63 |
| Control Panel | 13, 20, 102 |
| Copyright Holder | 110 |
| Copyright Information | 110 |
| Correcting images | 78 |
| Create New Folder | 107 |
| Crop | 47 |
| Cropping | 91 |
| Custom Image | 76 |
| Customization | 98 |
| Customization menus | 27 |

D

| | |
|------------------------------------|--------|
| Date Adjustment | 42 |
| Delete | 46, 85 |
| Delete All Images | 85 |
| Deleting selected images | 83 |
| Depth of field | 66 |
| Depth of Field Bracketing | 69 |
| Detailed information display | 15 |
| Developing RAW images | 89 |
| Dial | 10 |
| Dial indicator | 43 |
| Diffraction Correction | 79 |
| Digital Camera Utility 5 | 90, 94 |
| Digital Filter | 77, 88 |

| | | | |
|----------------------------|----------|--------------------------------|---------|
| Digital Preview..... | 66 | Filter | 77, 88 |
| Dioptr adjustment dial.... | 17 | Firmware Info/Options | 35 |
| Direct keys..... | 18 | Fish-eye (Digital Filter) | 88 |
| Distortion Correction..... | 79 | Flash..... | 75, 115 |
| Divide Movie..... | 92 | Flash compensation | 76 |
| DNG | 47 | Flash Mode..... | 75 |
| Drive mode | 67 | Flash On..... | 76 |
| Dust Removal..... | 120 | Flash X-sync Speed | 49 |
| Dynamic range | 78 | Flicker Reduction..... | 104 |
| Dynamic Range Correction | | Focal length input | 115 |
| | 78 | Focus Limiter..... | 65 |
| E | | Focus Magnification | 105 |
| E-Dial Programming | 100 | Focus method..... | 59 |
| Editing images..... | 88 | | 43, 59 |
| Electronic level | 18 | Focus Peaking..... | 64 |
| Electronic Level Type | | Folder display | 84 |
| | 103, 104 | Folder Name..... | 108 |
| Electronic Shutter | 54 | Format | 42 |
| Error messages | 122 | Four-way controller.... | 11, 18 |
| EV Compensation | 53 | Frame Composite (Digital | |
| EV Steps | 50 | Filter)..... | 88 |
| Exif data | 110 | Framerate..... | 48 |
| Expanded Area AF (phase- | | Fx Button | 98 |
| matching detection | | G | |
| autofocus)..... | 60 | GPS..... | 117 |
| Exposure in User Mode | | GPS Settings..... | 117 |
| | 97 | Grainy Monochrome (Digital | |
| Exposure mode | 49 | Filter)..... | 77, 88 |
| Exposure Simulation Live | | Grid Guide | 104 |
| View..... | 50 | H | |
| External flash..... | 115 | HDMI® terminal | 84 |
| Extract Movie..... | 92 | HDR Capture | 79 |
| Eye Sensor | 17, 103 | Headphone..... | 56 |
| F | | Headphone Volume..... | 48 |
| Face Detection | 64 | High Contrast (Digital Filter) | |
| Face Priority AE | 59 | | 77, 88 |
| File Format | 47 | High-ISO Noise Reduction | |
| File Name..... | 109 | | 58 |
| File Transfer | 87 | | |

| | |
|-----------------------------|-----|
| Highlight Correction | 78 |
| Highlight-weighted metering | |
| | 59 |
| Hold AF Status | 61 |
| Hot shoe | 75 |
| Hyper manual..... | 51 |
| HYPER P/Sv Options ... | 101 |
| Hyper program | 51 |

| | |
|-------------------------------|---------|
| I | |
| Image Capture Settings... | 47 |
| Image Copy | 87 |
| Image finishing tone | 76 |
| Image plane indicator | 9 |
| Image storage capacity | |
| | 127 |
| Image Sync | 95 |
| IMAGE Transmitter 2..... | 94 |
| Indicator Lamps | 106 |
| Information Display Outside | |
| Field of View | 17, 103 |
| Initial settings | 41 |
| Instant Review | 44, 105 |
| Interval Composite | 73 |
| Interval Shooting | 72 |
| Invert Color (Digital Filter) | |
| | 77, 88 |
| ISO Auto Lower Limit | 57 |
| ISO Auto Upper Limit | 57 |
| ISO Auto with Minimum | |
| Shutter Speed | 57 |
| ISO sensitivity..... | 57 |
| ISO Sensitivity Setting..... | 57 |
| ISO Sensitivity Steps..... | 57 |

| | |
|--------------------------|----|
| J | |
| JPEG | 47 |
| JPEG Quality | 47 |
| JPEG Recorded Pixels.... | 47 |

| | |
|---------------------------|---------|
| L | |
| Language setting..... | 42 |
| Language/言語 | 41 |
| LCD Panel | 16, 104 |
| Length Input on Startup | |
| | 115 |
| Lens..... | 36, 112 |
| Lens Correction | 79 |
| Lens focal length | 115 |
| Lens information contacts | |
| | 9 |
| Lens mount index | 9, 36 |
| Lens unlock button | 36 |
| Lens with aperture ring.. | 114 |
| Levels Adjustment | 91 |
| Lever..... | 10 |
| Link Exposure and Focus | |
| Point | 59 |
| Live View | 12, 104 |
| Low-pass filter | 80 |
| LV Shooting Touch AF ... | 50 |

| | |
|--------------------------------|------------|
| M | |
| M mode | 49 |
| Mac..... | 127 |
| Magnifying the image | |
| | 44, 45, 46 |
| Manual Exposure..... | 49 |
| Manual focus | 59 |
| ME viewfinder cap | 74 |
| Mechanical Shutter..... | 54 |
| Memory..... | 107 |
| Memory card..... | 40 |
| Memory Card Options | 47 |
| Menu..... | 20 |
| Meter Operating Time..... | 17 |
| MF Lens Focal Length... | 115 |
| Microphone | 9, 56 |
| Miniature (Digital Filter) ... | 88 |
| Minimum Shutter Speed.. | 57 |

| | | | |
|---|---------|--|---------|
| Still image setting menus | 22 | Using Aperture Ring | 114 |
| Still image/Live View/Movie selector dial | 43 | V | |
| Store Cursor Position | 21 | Vertical position | 13 |
| Strap | 36 | Viewfinder | 16 |
| Subject Recognition | 62 | Viewfinder Display ... | 17, 103 |
| Supplying power | 39 | Viewfinder Light | 103 |
| Sv mode | 49 | Viewfinder Screen | 103 |
| Sync socket 2P cap | 116 | Volume | 34 |
| | | Volume label | 42 |
| T | | W | |
| TAv mode | 49 | Warning Display | 106 |
| Tethered shooting | 94 | WARRANTY POLICY | 135 |
| Text entry | 96 | Wind Noise Reduction | 48 |
| Texture adjustment | 80 | Windows® | 127 |
| Thumbnail display | 46, 82 | Wireless LAN | 95 |
| TIFF | 89 | X | |
| Time | 52 | X mode | 49 |
| Timed exposure | 52 | X Mode Sync Speed | 49, 116 |
| Tone Expansion (Digital Filter) | 77, 88 | X-sync socket | 116 |
| Touch Image Browse Effect | 82 | Z | |
| Toy Camera (Digital Filter) | 77, 88 | Zone Select (contrast detection autofocus) | 63 |
| Tracking (contrast detection autofocus) | 63 | Zone Select (phase-matching detection autofocus) | 60 |
| Tripod socket | 9 | Zoom Review | 105 |
| Tv bracketing | 70 | | |
| Tv mode | 49 | | |
| U | | | |
| USB connection | 93, 127 | | |
| USB Power Supply to External Device | 39 | | |
| USB Setting | 93 | | |
| USB terminal | 38, 93 | | |
| User registration | 6 | | |
| User Settings Restoration | 97 | | |

Care to be Taken During Handling

Before Using Your Camera

- When the camera has not been used for a long time, confirm that it is still working properly, particularly prior to taking important images (such as at a wedding or when traveling). Contents of the recording cannot be guaranteed if recording, playback, or transferring your data to a computer, etc. is not possible due to a malfunction of your camera or recording media (memory cards), etc.

About the Battery and Charger

- To keep the battery in optimum condition, avoid storing it in a fully charged state or in high temperatures.
- If the battery is left inserted and the camera is not used for a long time, the battery will over-discharge and shorten the battery's life.
- Charging the battery a day before use or on the day of use is recommended.

Precautions on Carrying and Using Your Camera

- Do not subject the camera to high temperatures or high humidity. Do not leave the camera in a vehicle, as the temperature can get very high.
- Do not subject the camera to strong vibrations, shocks, or pressure. Use a cushion to protect the camera from vibrations of motorcycles, automobiles, or ships.
- The temperature range for camera use is -10°C to 40°C (14°F to 104°F).
- The monitor may appear black at high temperatures, but will return to normal at normal temperatures.
- The monitor may respond more slowly at low temperatures. This is due to liquid crystal properties, and is not a malfunction.
- Sudden temperature changes will cause condensation on the inside and outside of the camera. Place the camera in your bag or a plastic bag, and remove it after temperatures of the camera and surroundings are equalized.
- Avoid contact with garbage, mud, sand, dust, water, toxic gases, or salt. These could cause the camera to breakdown. Wipe the camera to dry off any rain or water drops.
- Do not press on the monitor with excessive force. This could cause it to break or malfunction.
- Be careful not to overtighten the screw in the tripod socket when using a tripod.

Cleaning Your Camera

- Do not clean the camera with organic solvents such as thinner, alcohol, and benzine.
- Use a lens brush to remove dust accumulated on a lens. Never use a spray blower for cleaning as it may damage the lens.
- Please contact your nearest service center for professional cleaning of the CMOS sensor. (This will involve a fee.)
- Periodic inspections are recommended every one to two years to maintain high performance.

Storing Your Camera

- Do not store the camera with preservatives or chemicals. Storage in high temperatures and high humidity can cause mold to grow on the camera. Remove the camera from its case and store it in a dry and well-ventilated place.
- Avoid using or storing the camera where it may be exposed to static electricity or electrical interference.
- Avoid using or storing the camera in direct sunlight or in locations where it may be exposed to rapid changes in temperature or to condensation.

About SD Memory Cards

- The SD Memory Card is equipped with a write-protect switch. Setting the switch to LOCK prevents new data from being recorded on the card, the stored data from being deleted, and the card from being formatted by the camera or computer.
- The SD Memory Card may be hot when removing the card immediately after using the camera.
- Do not remove the SD Memory Card or turn off the power while the card is being accessed. This may cause the data to be lost or the card to be damaged.
- Do not bend the SD Memory Card or subject it to violent impact. Keep it away from water and store away from high temperatures.
- Do not remove the SD Memory Card while formatting. The card may be damaged and become unusable.
- Data on the SD Memory Card may be deleted in the following circumstances. We do not accept any liability for data that is deleted if
 1. the SD Memory Card is mishandled by the user;
 2. the SD Memory Card is exposed to static electricity or electrical interference;
 3. the SD Memory Card has not been used for a long time;

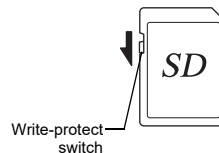

4. the SD Memory Card or the battery is removed while the card is being accessed.
- If the SD Memory Card is not used for a long time, the data on the card may become unreadable. Be sure to regularly make a backup of important data on a computer.
 - Format new SD Memory Cards. Also format SD Memory Cards previously used with other cameras.
 - Please note that deleting data stored on an SD Memory Card, or formatting an SD Memory Card does not completely erase the original data. Deleted data can sometimes be recovered using commercially available software. If you are going to discard, give away, or sell your SD Memory Card, you should ensure that the data on the card is completely deleted or the card itself is destroyed if it contains any personal or sensitive information.
 - The data on your SD Memory Card should be managed at your own risk.

Trademarks

- Microsoft and Windows are registered trademarks of Microsoft Corporation in the United States of America and other countries.
- Mac and macOS are trademarks of Apple Inc., registered in the U.S. and other countries.
- IOS is a trademark or registered trademark of Cisco in the U.S. and other countries and is used under license.
- Intel and Intel Core are trademarks of Intel Corporation in the U.S. and/or other countries.
- SDXC Logo is a trademark of SD-3C, LLC.
- The Bluetooth word mark and logos are registered trademarks owned by Bluetooth SIG, Inc., and any use of such marks by Ricoh Company, Ltd. is under license.
- USB Type-C is a trademark of USB Implementers Forum.
- This product includes DNG technology under license by Adobe Systems Incorporated.
- The DNG logo is either a registered trademark or trademark of Adobe Systems Incorporated in the United States and/or other countries.
- HDMI, the HDMI logo and High-Definition Multimedia Interface are trademarks or registered trademarks of HDMI Licensing, LLC in the United States and/or other countries.

All other trademarks are the property of their respective owners.

- This product uses the RICOH RT font designed by Ricoh Company Ltd.
- This product supports PRINT Image Matching III. PRINT Image Matching-enabled digital still cameras, printers, and software help photographers to produce images more faithful to their intentions. Some functions are not available on printers that are not PRINT Image Matching III compliant.

Copyright 2001 Seiko Epson Corporation. All Rights Reserved. PRINT Image Matching is a trademark of Seiko Epson Corporation. The PRINT Image Matching logo is a trademark of Seiko Epson Corporation.



AVC Patent Portfolio License

This product is licensed under the AVC Patent Portfolio License for the personal use of a consumer or other uses in which it does not receive remuneration to (i) encode video in compliance with the AVC standard ("AVC video") and/or (ii) decode AVC video that was encoded by a consumer engaged in a personal activity and/or was obtained from a video provider licensed to provide AVC video. No license is granted or shall be implied for any other use.

Additional information may be obtained from MPEG LA, L.L.C.
See <https://www.mpegla.com>.

Announcement about the Open Source Software

This camera includes the open source software (OSS) licensed under the GNU General Public License (GPL), GNU Lesser General Public License (LGPL), and/or other licenses. The information about licenses of each OSS used in the camera is saved in the camera internal memory as a text file. Connect the camera to a computer, access the "oss_license" folder, and open each text file to read the license terms.

The source codes of OSS used in the camera are disclosed under the license terms of GPL, LGPL, etc. If you need the source codes, access the following URL.

<https://www.rioh-imaging.co.jp/english/products/oss/>

Announcement on the Use of BSD-Licensed Software

This product includes software licensed under the BSD License. BSD license is a form of license which permits the redistribution of the software provided that it is clearly stated that use is unwarranted, and a copyright notice and a list of licensing conditions are provided. The following contents are displayed based on the abovementioned licensing conditions and are not for the purpose of restricting your use of the product, etc.

Tera Term

Copyright (C) 1994-1998 T. Teranishi

(C) 2004-2018 TeraTerm Project

All rights reserved.

Redistribution and use in source and binary forms, with or without modification, are permitted provided that the following conditions are met:

1. Redistributions of source code must retain the above copyright notice, this list of conditions and the following disclaimer.
2. Redistributions in binary form must reproduce the above copyright notice, this list of conditions and the following disclaimer in the documentation and/or other materials provided with the distribution.
3. The name of the author may not be used to endorse or promote products derived from this software without specific prior written permission.

THIS SOFTWARE IS PROVIDED BY THE AUTHOR "AS IS" AND ANY EXPRESS OR IMPLIED WARRANTIES, INCLUDING, BUT NOT LIMITED TO, THE IMPLIED WARRANTIES OF MERCHANTABILITY AND FITNESS FOR A PARTICULAR PURPOSE ARE DISCLAIMED. IN NO EVENT SHALL THE AUTHOR BE LIABLE FOR ANY DIRECT, INDIRECT, INCIDENTAL, SPECIAL, EXEMPLARY, OR CONSEQUENTIAL DAMAGES (INCLUDING, BUT NOT LIMITED TO, PROCUREMENT OF SUBSTITUTE GOODS OR SERVICES; LOSS OF USE, DATA, OR PROFITS; OR BUSINESS INTERRUPTION) HOWEVER CAUSED AND ON ANY THEORY OF LIABILITY, WHETHER IN CONTRACT, STRICT LIABILITY, OR TORT (INCLUDING NEGLIGENCE OR OTHERWISE) ARISING IN ANY WAY OUT OF THE USE OF THIS SOFTWARE, EVEN IF ADVISED OF THE POSSIBILITY OF SUCH DAMAGE.

WARRANTY POLICY

All our cameras purchased through authorized bona fide photographic distribution channels are guaranteed against defects of material or workmanship for a period of twelve months from the date of your purchase. Service will be rendered, and defective parts will be replaced without cost to you within that period, provided the camera does not show evidence of impact, sand or liquid damage, mishandling, tampering, battery or chemical corrosion, operation contrary to operating instructions, or modification by an unauthorized repair shop. The manufacturer or its authorized representatives shall not be liable for any repair or alterations except those made with its written consent and shall not be liable for damages from delay or loss of use or from other indirect or consequential damages of any kind, whether caused by defective material or workmanship or otherwise; and it is expressly agreed that the liability of the manufacturer or its representatives under all guarantees or warranties, whether expressed or implied, is strictly limited to the replacement of parts as hereinbefore provided. No refunds will be made on repairs by non-authorized service facilities.

Procedure During 12-month Warranty Period

Any camera which proves defective during the 12-month warranty period should be returned to the dealer from whom you purchased the camera or to the manufacturer. If there are no representatives of the manufacturer in your country, send the camera to the manufacturer, with postage prepaid. In this case, it will take a considerable length of time before the camera can be returned to you owing to the complicated customs procedures required. If the camera is covered by warranty, repairs will be made and parts replaced free of charge, and the camera will be returned to you upon completion of servicing. If the camera is not covered by warranty, regular charges of the manufacturer or of its representatives will apply. Shipping charges are to be borne by the owner. If your camera was purchased outside of the country where you wish to have it serviced during the warranty period, regular handling and

servicing fees may be charged by the manufacturer's representatives in that country. Notwithstanding this, your camera returned to the manufacturer will be serviced free of charge according to this procedure and warranty policy. In any case, however, shipping charges and customs clearance fees to be borne by the sender. To prove the date of your purchase when required, please keep the receipt or bills covering the purchase of your camera for at least a year. Before sending your camera for servicing, please make sure that you are sending it to the manufacturer's authorized representatives or their approved repair shops, unless you are sending it directly to the manufacturer. Always obtain a quotation for the service charge, and only after you accept the quoted service charge, instruct the service station to proceed with the servicing.

- **This warranty policy does not affect the customer's statutory rights.**
- **The local warranty policies available from our distributors in some countries can supersede this warranty policy. Therefore, we recommend that you review the warranty card supplied with your product at the time of purchase, or contact our distributor in your country for more information and to receive a copy of the warranty policy.**

For Customers in USA STATEMENT OF FCC COMPLIANCE

This device complies with Part 15 of the FCC Rules. Operation is subject to the following two conditions: (1) This device may not cause harmful interference, and (2) this device must accept any interference received, including interference that may cause undesired operation.

FCC CAUTION:

Changes or modifications not expressly approved by the party responsible for compliance could void the user's authority to operate the equipment.

This equipment has been tested and found to comply with the limits for a Class B digital device, pursuant to part 15 of the FCC Rules. These limits are designed to provide reasonable protection against harmful interference in a residential installation. This equipment generates, uses and can radiate radio frequency energy and, if not installed and used in accordance with the instructions, may cause harmful interference to radio communications. However, there is no guarantee that interference will not occur in a particular installation. If this equipment does cause harmful interference to radio or television reception, which can be determined by turning the equipment off and on, the user is encouraged to try to correct the interference by one or more of the following measures:

- Reorient or relocate the receiving antenna.
- Increase the separation between the equipment and receiver.
- Connect the equipment into an outlet on a circuit different from that to which the receiver is connected.
- Consult the dealer or an experienced radio/TV technician for help.

This transmitter must not be co-located or operated in conjunction with any other antenna or transmitter.

The available scientific evidence does not show that any health problems are associated with using low power wireless devices. There is no proof, however, that these low power wireless devices are absolutely safe. Low power Wireless devices emit low levels of radio frequency energy (RF) in the microwave range while being used. Whereas high levels of RF can produce health effects (by heating tissue), exposure of low-level RF that does not produce heating effects causes no known adverse

health effects. Many studies of low-level RF exposures have not found any biological effects. Some studies have suggested that some biological effects might occur, but such findings have not been confirmed by additional research. R03010 has been tested and found to comply with FCC radiation exposure limits set forth for an uncontrolled environment and meets the FCC radio frequency (RF) Exposure Guidelines.

Declaration of Conformity According to 47CFR, Parts 2 and 15 for Class B Personal Computers and Peripherals

We: RICOH IMAGING AMERICAS
CORPORATION

Located at: 2 Gatehall Drive Suite 204,
Parsippany, New Jersey 07054,
U.S.A.
Phone: 800-877-0155

Declare under sole responsibility that the product identified herein complies with 47CFR Parts 2 and 15 of the FCC rules as a Class B digital device. Each product marketed is identical to the representative unit tested and found to be compliant with the standards. Records maintained continue to reflect the equipment being produced can be expected to be within the variation accepted, due to quantity production and testing on the statistical basis as required by 47CFR §2.909. Operation is subject to the following two conditions: (1) This device may not cause harmful interference, and (2) This device must accept any interference received, including interference that may cause undesired operation. The above named party is responsible for ensuring that the equipment complies with the standards of 47CFR §15.101 to §15.109.

Product Name: Digital Camera
Model Number: R03010
Contact Person: Customer Service Manager
Date and Place: September, 2020 Parsippany

For Customers in USA and Canada

Lithium-ion batteries are recyclable.

You can help preserve our environment by returning your used rechargeable batteries to the collection and recycling location nearest you.

For more information regarding recycling of rechargeable batteries, call toll free 1-800-822-8837, or visit <https://www.call2recycle.org/>.

For Customers in Canada

Innovation, Science and Economic Development Canada (ISED) Regulatory Compliance Notice

This Class B digital apparatus complies with Canadian ICES-003 (B).

This device contains licence-exempt transmitter(s)/receiver(s) that comply with Innovation, Science and Economic Development Canada's licence-exempt RSS(s). Operation is subject to the following two conditions:

1. This device may not cause interference.
2. This device must accept any interference, including interference that may cause undesired operation of the device.

The available scientific evidence does not show that any health problems are associated with using low power wireless devices. There is no proof, however, that these low power wireless devices are absolutely safe. Low power wireless devices emit low levels of radio frequency energy (RF) in the microwave range while being used. Whereas high levels of RF can produce health effects (by heating tissue), exposure of low-level RF that does not produce heating effects causes no known adverse health effects. Many studies of low-level RF exposures have not found any biological effects. Some studies have suggested that some biological effects might occur, but such findings have not been confirmed by additional research. The R03010 has been tested and found to comply with ISED radiation exposure limits set forth for an uncontrolled environment and meets RSS-102 of the ISED radio frequency (RF) Exposure rules.

Pour les utilisateurs au Canada

Avis de conformité à la réglementation d'Innovation, Sciences et Développement économique Canada (ISDE)

Cet appareil numérique de la classe B est conforme à la norme NMB-003 (B) du Canada.

L'émetteur/récepteur exempt de licence contenu dans le présent appareil est conforme aux CNR d'Innovation, Sciences et Développement économique Canada applicables aux appareils radio exempts de licence. L'exploitation est autorisée aux deux conditions suivantes :

1. L'appareil ne doit pas produire de brouillage ;
2. L'appareil doit accepter tout brouillage radioélectrique subi, même si le brouillage est susceptible d'en compromettre le fonctionnement.

Les connaissances scientifiques dont nous disposons n'ont mis en évidence aucun problème de santé associé à l'usage des appareils sans fil à faible puissance. Nous ne sommes cependant pas en mesure de prouver que ces appareils sans fil à faible puissance émettent une énergie fréquence radioélectrique (RF) très faible dans le spectre des micro-ondes lorsqu'ils sont utilisés. Alors qu'une dose élevée de RF peut avoir des effets sur la santé (en chauffant les tissus), l'exposition à de faibles RF qui ne produisent pas de chaleur n'a pas de mauvais effets connus sur la santé. De nombreuses études ont été menées sur les expositions aux RF faibles et n'ont découvert aucun effet biologique. Certaines études ont suggéré qu'il pouvait y avoir certains effets biologiques, mais ces résultats n'ont pas été confirmés par des recherches supplémentaires. Le R03010 a été testé et jugé conforme aux limites d'exposition aux rayonnements ISDE énoncées pour un environnement non contrôlé et respecte les règles d'exposition aux fréquences radioélectriques (RF) CNR-102 de l'ISDE.

For Customers in Europe

Information for Users on Collection and Disposal of Old Equipment and Used Batteries



1. In the European Union

These symbols on the products, packaging and/or accompanying documents mean that used electrical and electronic equipment and batteries should not be mixed with general household waste.

Used electrical/electronic equipment and batteries must be treated separately and in accordance with legislation that requires proper treatment, recovery and recycling of these products.



By disposing of these products correctly you will help ensure that the waste undergoes the necessary treatment, recovery and recycling and thus prevent potential negative effects on the environment and human health which could otherwise arise due to inappropriate waste handling.

If a chemical symbol is added beneath the symbol shown above, in accordance with the Battery Directive, this indicates that a heavy metal (Hg = Mercury, Cd = Cadmium, Pb = Lead) is present in the battery at a concentration above an applicable threshold specified in the Battery Directive.

For more information about collection and recycling of used products, please contact your local authorities, your waste disposal service or the point of sale where you purchased the products.

2. In other countries outside the EU

These symbols are only valid in the European Union. If you wish to discard used products, please contact your local authorities or dealer and ask for the correct method of disposal.

For Switzerland: Used electrical/electronic equipment can be returned free of charge to the dealer, even when you don't purchase a new product. Further collection facilities are listed on the home page of www.swico.ch or www.sens.ch.

CAUTION:
RISK OF EXPLOSION IF BATTERY IS REPLACED BY AN INCORRECT TYPE. DISPOSE OF USED BATTERIES ACCORDING TO THE INSTRUCTIONS.



Points de collecte sur www.quefairedemesdechets.fr
Privilégiez la réparation ou le don de votre appareil !

Notice to Users in CE Marking

This product complies with the essential requirements and provisions of RE Directive 2014/53/EU.

The EU Declaration of Conformity is available by accessing the URL:

https://www.ricoh-imaging.co.jp/english/support/declaration_of_conformity.html
and selecting the product applicable.

Operating frequency band: 2400 MHz - 2483.5 MHz

Maximum radio-frequency power: 14 dBm EIRP

Importer (CE marking): RICOH IMAGING EUROPE S.A.S.
Parc Tertiaire SILIC 7-9, avenue Robert Schuman - B.P. 70102,
94513 Rungis Cedex, FRANCE

Manufacturer: RICOH IMAGING COMPANY, LTD.
1-3-6, Nakamagome, Ohta-ku, Tokyo 143-8555, JAPAN



The CE Mark is a Directive conformity mark of the European Union.

Notice to Users in UKCA Marking

This product complies with the essential requirements and provisions of Radio Equipment Regulations 2017.

The UK Declaration of Conformity is available by accessing the URL:

https://www.ricoh-imaging.co.jp/english/support/declaration_of_conformity.html
and selecting the product applicable.

Operating frequency band: 2400 MHz - 2483.5 MHz

Maximum radio-frequency power: 14 dBm EIRP

Manufacturer: RICOH IMAGING COMPANY, LTD.
1-3-6, Nakamagome, Ohta-ku, Tokyo 143-8555, JAPAN



The UKCA Mark is a Regulation conformity mark of the United Kingdom.

For Customers in Thai

This telecommunication equipment conforms to the requirements of the Office of the National Broadcasting and Telecommunications Commission.



nab.

เครื่องวิทยุคมนาคมนี้ ได้รับยกเว้น ไม่ต้องได้รับใบอนุญาตให้มี ใช้ซึ่งเครื่องวิทยุคมนาคมหรือตั้งสถานีวิทยุคมนาคมตามประกาศ กสทช. เรื่อง เครื่องวิทยุคมนาคม และสถานีวิทยุคมนาคมที่ได้รับยกเว้นไม่ต้องได้รับใบอนุญาตวิทยุคมนาคม ตามพระราชบัญญัติวิทยุคมนาคม พ.ศ. 2498



nab. | โทรคมนาคม
กำกับดูแลเมื่อประชาชน
Call Center 1200 (Insw5)

RICOH

RICOH IMAGING COMPANY, LTD.

1-3-6, Nakamagome, Ohta-ku, Tokyo 143-8555, JAPAN
(<https://www.ricoh-imaging.co.jp>)

RICOH IMAGING EUROPE S.A.S.

Parc Tertiaire SILIC 7-9, avenue Robert Schuman - B.P. 70102,
94513 Rungis Cedex, FRANCE
(<https://www.ricoh-imaging.eu>)

RICOH IMAGING AMERICAS CORPORATION

2 Gatehall Drive Suite 204, Parsippany, New Jersey 07054, U.S.A.
(<https://www.us.ricoh-imaging.com>)

RICOH IMAGING CANADA INC.

5560 Explorer Drive Suite 100, Mississauga, Ontario, L4W 5M3, CANADA
(<https://www.ricoh-imaging.ca>)

RICOH IMAGING CHINA CO., LTD.

Room A 23F Lansheng Building, 2-8 Huaihaizhong Road, Huangpu District,
Shanghai, 200021, CHINA
(<http://www.ricoh-imaging.com.cn>)

<https://www.ricoh-imaging.co.jp/english/>

This contact information may change without notice.
Please check the latest information on our websites.

- Specifications and external dimensions are subject to change without notice.



4RFNZ020+